

A0
INOX
A-CERO INOX



EQUIPAMIENTO HOSTELERO PROFESIONAL

2022

ENERO 2022



A-CERO INOX



A-CERO INOX Somos una empresa dedicada a la fabricación de mobiliario y equipamiento profesional en acero inoxidable. Ofrecemos un producto de alta calidad, tanto en la gama estándar, presentada en este catálogo, como en producto a medida. Evolucionamos, día a día, cada diseño, buscando mejorar al máximo nuestros productos. Nuestro dinámico sistema de diseño y nuestro flexible sistema de producción, nos permite personalizar líneas de producto y reducir plazos de entrega. A-CERO INOX es una marca de referencia en calidad y servicio, en productos de acero inoxidable.

A-CERO INOX., is a company committed to manufacturing furniture and professional equipment in stainless steel. We offer a high quality product in standard range, presented in this catalogue, as well as in custom made products. We evolve, day after day, each design trying to improve our products as much as possible. Our dynamic design system and our flexible manufacturing system enables us to customize product lines and reduce lead times.

A-CERO INOX., is a reference brand in quality and service in stainless steel products

A-CERO INOX S.L. Nous sommes une société dédiée à la fabrication de meubles et d'équipements professionnels en acier inoxydable. Nous offrons un produit de haute qualité à la fois dans la gamme standard, présenté dans ce catalogue, et dans le produit personnalisé. Nous évoluons chaque jour dans le design en cherchant à améliorer nos produits au maximum. Notre système de conception et de production flexible nous permet de personnaliser les gammes de produits et de réduire les délais pour nos clients.

A-CERO INOX est une marque de confiance en qualité et en service dans les produits en acier inoxydable.





A-CERO INOX Cuenta con un departamento propio de ingeniería, que permite personalizar cada diseño, para adaptarlo a las necesidades de cada cliente.

Todos nuestros productos, presentados en este catálogo, son revisados y actualizados continuamente, mejorando la estética, funcionalidad y durabilidad. Nos esforzamos para ofrecer a nuestros clientes, un producto de calidad a un precio competitivo

A-CERO INOX., has its own engineering department which enables to customize each design adapting them to the needs of each customer.

All of our products, presented in this catalogue, are review and update constantly improving the esthetic, functionality and resistance. We aim to offer our customers a quality product with a competitive price.

A-CERO INOX S.L. a son propre département d'ingénierie qui nous permet de personnaliser chacun de nos modèles en fonction des besoins de nos clients.

Tous nos produits présentés dans ce catalogue sont continuellement revus et évolués améliorant ainsi les finitions esthétiques, la fonctionnalité et la résistance à l'utilisation. Nous nous efforçons chaque jour d'offrir à nos clients un produit de haute qualité à un prix compétitif.



Respetuosos con el medio todos nuestros procesos productivos están orientados a reducir nuestra huella de carbono, además nuestros aparatos se fabrican y se emballan con material 100% reciclable.

Environmentally friendly, all our production processes are focused to reduce our carbon footprint; moreover, our devices are manufactured and packed with recycled materials.

Respectueux de l'environnement tous nos processus de production visent à réduire notre empreinte carbone, en outre nos appareils sont fabriqués et emballés avec des matériaux 100% recyclables.



A-CERO INOX EN LAS REDES



Síguenos en las redes sociales,

Instagram: @a0_inox

Facebook: A-CERO INOX S.L.

Linkedin: A-CERO INOX S.L.

VISITA NUESTRA WEB



[WWW.A-CEROINOX.COM](http://www.a-ceroinox.com)

En nuestra web www.a-ceroinox.com encontrarás, contenido actualizado, información de producto, descarga de documentación, información técnica y herramientas que facilitan la implantación de soluciones.

On our website www.a-ceroinox.com you can find, updated content, product information, download documents, technical information and software tools which will facilitate the implementation of solutions.

Sur notre site web www.a-ceroinox.com vous trouverez du contenu mis à jour, des informations sur les produits, de la documentation de téléchargement, des informations techniques et des outils qui aident dans le travail quotidien.

CONTACTA CON NOSOTROS

A-CERO INOX S.L.

C/ La industria 6
Pol. Ind. Alcamar
Camarma de Esteruelas
C.P.: 28816 - (Madrid)
Tel.: +34 916 035 460
mail: ventas@a-ceroinox.com
web: www.a-ceroinox.com

DELEGACIONES COMERCIALES

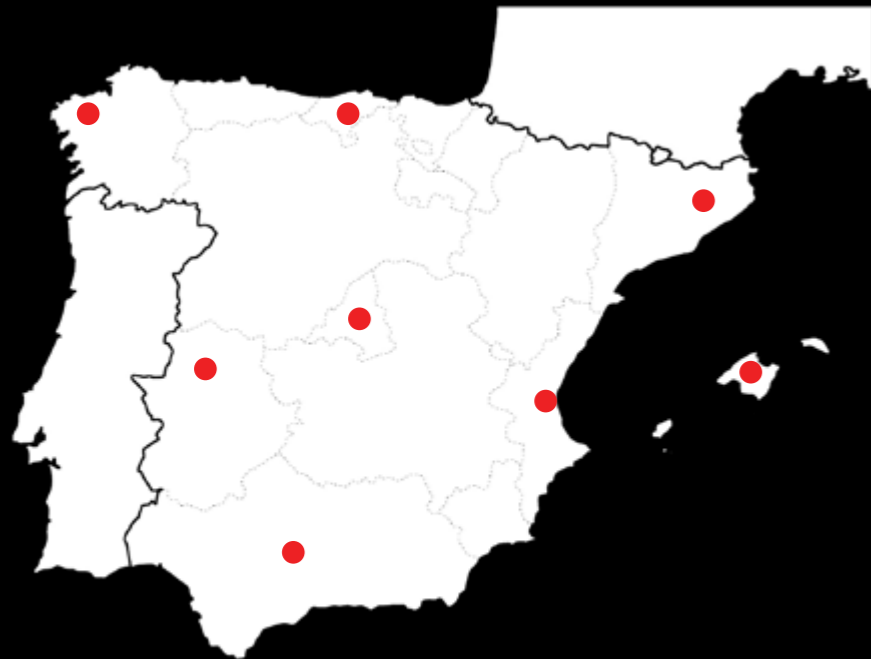



SERVICIO DE ATENCION AL CLIENTE Disponemos de un departamento de atención al cliente donde atenderemos cualquier consulta previa a la recepción del pedido, así como de un servicio postventa para dar solución a cualquier incidencia que pueda surgir. El departamento comercial informará del estado y evolución del pedido y coordinará la entrega del mismo al cliente.

ENTREGA EN 24 H En una amplia selección del producto presentado en este catálogo.

INSTALACION Y SERVICIO TECNICO Ofrecemos a nuestros clientes un equipo propio de instalación y servicio técnico, capaces de instalar toda nuestra gama de productos así como otros, fabricados por terceros, para garantizar un óptimo acabado en las instalaciones.

SERVICIO POSTVENTA Nuestro compromiso con el cliente no termina con la entrega de su pedido; seguimos dándole asistencia en la resolución de cualquier duda que pueda surgirles con el producto adquirido.

MEDICION Y PRESENTACION PREVIA Disponemos de un departamento técnico con gran experiencia en mediciones y asesoramiento en soluciones de equipamiento. Realizamos una presentación previa en 3D para verificación estética y constructiva del equipo antes de su fabricación.



CUSTOMER SERVICE. Our customer service department will respond any previous query as well as after-sales service to solve any incidence that might come up. Our sales department will inform about the status and development of the order and will coordinate the delivery to the customer.

24-HOUR DELIVERY SERVICE In a large selection of products displayed in this catalogue.

INSTALLATION AND TECHNICAL SERVICE We offer our customers a professional team of installers and technical service, able to set up all our products as well as others, fabricated by third parties, in order to assure an optimal assembly of the whole equipment.

AFTER-SALE SERVICE Our commitment with our customers does not end with the shipment of your order, we continue assisting in the solution of any doubt that your might have with the purchased product.

MEASUREMENT AND PRIOR PRESENTATION. We have a technical department, with an extensive experience in measurement and consulting in equipment solutions. We can make a prior presentation on 3D to check the aesthetic and construction features of the equipment before its manufacturing.

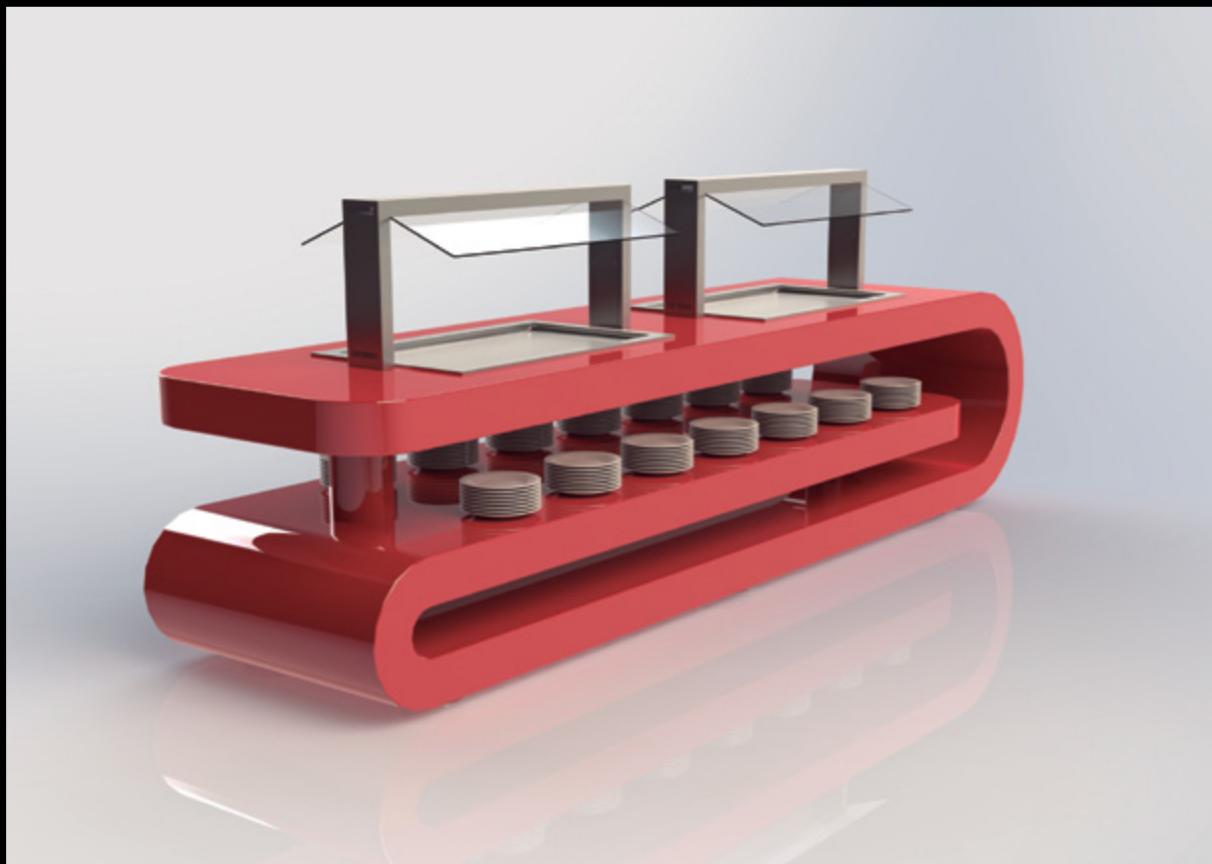



SERVICE À LA CLIENTÈLE Nous avons un service à la clientèle où nous assisterons à toutes les demandes avant la réception de la commande ou du service après-vente pour résoudre tout incident qui pourrait survenir à la réception des marchandises. Notre service des ventes informera toujours l'état de réception et l'évolution de la commande et coordonnera la livraison de la commande afin de faciliter le travail quotidien des clients.

LIVRAISON EN 24 H Dans une large sélection du produit présenté dans ce catalogue.

INSTALLATION ET SERVICE TECHNIQUE Nous fournissons à nos clients nos propres équipements d'installation et de service technique. Nous offrons la possibilité de fournir et d'installer des produits fabriqués par nous ou par des tiers pour collaborer avec nos distributeurs.

SERVICE POST-VENTE Notre engagement envers le client ne se termine pas par la livraison de votre commande. Nous restons à votre disposition pour vous aider à résoudre toutes les questions qui peuvent se poser avec le produit acheté.

MEDICION ET PRÉSENTATION PRÉCÉDENTE Nous avons un département technique avec une grande expérience dans les mesures et des conseils sur les solutions d'équipement. Nous faisons une présentation 3D précédente pour la vérification esthétique et constructive de l'équipement avant sa fabrication.



ÍNDICE

Pág. 24 - FREGADEROS Y LAVADO. Una gama completa de fregaderos que proporcionan solución a cualquier necesidad completamente fabricados en AISI 304. Completa esta propuesta con lavamanos, mesas de entrada y salida de lavavajillas y grifería apta para cualquier uso en zonas de cocina o lavado de vajilla.

Pág. 46 - MESAS Y ARMARIOS. Mesas totalmente soldadas, puertas deslizantes con suavidad, cajones que se abren automáticamente al pulsarlos. Mesas calientes y neutras, abiertas o con puertas. Armarios de vajilla, limpieza o murales. Todo fabricado con acero inoxidable AISI 304.

Pág. 68 - ESTANTERIAS Y ESTANTES. Estanterías de aluminio, robustas, limpias y fáciles de montar. Estante de pared para cualquier necesidad, fijos, con tubos, con parrillas gastronorm, para microondas, para cestas ...

Pág. 78 - CARROS Y DISTRIBUCION. Solución completa para las zonas de emplatado con cintas transportadoras y carros de apoyo a estas cintas. Cintas de recogida de auto servicio y toda una gama de carros para cualquier tipo de bandeja.

Pág. 92- CAMPANAS. Amplia oferta de modelos de campanas para humos, para vapor de agua, para hornos, con aportación, con inducción... complétalas con iluminación tipo led o cualquiera de los accesorios que proponemos.

Pág. 100 - BUFFET Y AUTOSERVICIO. Diseño sin límites para nuestros buffet. Autoservicios a medida o simplemente equipor drop-in para cualquier buffet.

Pág. 116 - PROYECTOS E INSTALACIONES. Un breve recorrido por algunas de las instalaciones realizadas por nuestro equipo en los últimos meses.



INDEX

Pág. 24 - SINKS AND WASHING. A complete range of sinks that provide a solution to any need completely made of AISI 304. Complete this proposal with a sink, dishwasher inlet and outlet tables and taps suitable for any use in kitchen or dishwashing areas.

Pág. 46 - TABLES AND CABINETS. Fully welded tables, smoothly sliding doors, drawers that open automatically when pressed. Hot and neutral tables, open or with doors. Tableware, cleaning or wall cabinets. All made of AISI 304 stainless steel.

Pág. 68 - SHELVES AND SHELVES. Aluminum shelves, robust, clean and easy to assemble. Wall shelf for any need, fixed, with tubes, with gastronorm grills, for microwaves, for baskets ...

Pág. 78 - CARS AND DISTRIBUTION. Complete solution for plating areas with conveyor belts and trolleys to support these belts. Self-service collection belts and a whole range of trolleys for any type of tray.

Pág. 92 - HOODS: Wide range of models of hoods for fume, for steam, for ovens, with contribution, with induction ... complete them with LED lighting or any of the accessories that we propose.

Pág. 100 - BUFFET AND SELF-SERVICE. Design without limits for our buffets. Custom self-services or simply drop-in equipment for any buffet.

Pág. 116 - PROJECTS AND FACILITIES. A brief tour of some of the installations carried out by our team in recent months.



INDEX

Pág. 24 - ÉVIERS ET LAVAGE. Une gamme complète d'éviers qui apportent une solution à tout besoin entièrement en AISI 304. Complétez cette proposition avec un évier, des tables d'entrée et de sortie pour lave-vaisselle et des robinets adaptés à toute utilisation dans la cuisine ou la vaisselle.

Pág. 46 - TABLES ET ARMOIRES. Tables entièrement soudées, portes coulissantes en douceur, tiroirs qui s'ouvrent automatiquement lorsqu'ils sont pressés. Tables chaudes et neutres, ouvertes ou avec portes. Vaisselle, nettoyage ou armoires murales. Tous fabriqués en acier inoxydable AISI 304.

Pág. 68 - ÉTAGÈRES. Étagères en aluminium, robustes, propres et faciles à monter. Étagère murale pour tous les besoins, fixe, avec tubes, avec grilles gastronormes, pour micro-ondes, pour paniers ...

Pág. 78 - CHARRIOTS ET DISTRIBUTION. Solution complète pour les zones de placage avec des bandes transporteuses et des chariots pour supporter ces bandes. Des tapis de collecte en libre service et toute une gamme de chariots pour tout type de plateau.

Pág. 92 - HOTTES. Une large gamme de modèles de hottes pour la fumée, de la vapeur, pour les fours, avec la contribution, à l'induction ... les compléter avec un éclairage LED ou l'un des accessoires que nous proposons.

Pág. 100 - BUFFET ET LIBRE-SERVICE. Design sans limites pour nos buffets. Des self-services sur mesure ou simplement des équipements en libre-service pour tout buffet.

Pág. 116 - PROJETS ET INSTALLATIONS. Petit tour de quelques installations réalisées par notre équipe au cours des derniers mois.





Fregaderos y lavado.

Sinks and washing. / Éviers et lavage.

	pág.
FREGADEROS GAMA 600 Y 700 / 600 AND 700 SINKS RANGE / EVIERS GAMME 600 ET 700	27
FREGADEROS DE GRAN CAPACIDAD / HIGH CAPACITY SINK / ÉVIERS GRANDE CAPACITÉ	28
FREGADEROS GAMA 550 / 550 SINKS RANGE / EVIERS GAMME 550	28
FREGADEROS PARA LAVAVAJILLA / DISHWASHER SINKS / EVIERS POUR LAVE-VAISSELLE	29
FREGADEROS GAMA 500 / 500 SINK RANGE / EVIERS GAMME 500	30
FREGADERO VERTEDERO / OUTLET SINK / ÉVIER DÉVERSOIR	30
FREG. CON ARO DE DESBARACE / HASTE HOLE SINKS / EVIERS AVEC TROU VIDE DÉCHETS	31
FREGADEROS PARA VERDURAS / VEGETABLE SINKS / EVIERS DE PRÉPARATION DE LÉGUMES	31
FREGADEROS CON ARMARIO / SINKS WITH OVER CUPBOARD / EVIERS AVEC ARMOIRE	32
ENCIMERAS PARA FREGADEROS / SINK WORK TOP / PLAN DE TRAVAIL POR ÉVIERS	34
SOPORTES PARA FREGADEROS / SINK SUPPORT / SUPPORT POUR ÉVIERS	37
PETO LATERAL PARA FREGADEROS / TOP SIDE SINK PANEL / DOSSERET POUR ÉVIERS	37
ESTANTE INFERIOR / LOWER SHELF / ETAGÈRE	37
GRIFERÍA / TAPS / ROBINETS	38
LAVAMANOS DE PIE / HANDWASH BASIN / LAVE-MAINS	40
LAVAMANOS MURAL / WALL HANDWASH / LAVE-MAINS MURAL	41
MESAS PARA LAVAVAJILLAS / DISHWASHER TABLES / TABLES DE LAVE-VAISSELLE	42
MESAS DE RODILLOS / ROLLER TABLES / TABLES À ROULEAUX	44
SOPORTE CESTAS / BASKET SUPPORT / SUPPORT DE PANIER	44
BANCADAS / SUPPORT	44
MESAS DE RECEPCIÓN DE SUCIO / RECEPTION TABLE / TABLE DE RÉCEPTION	45



FREGADEROS

SINKS / EVIERS

Totalmente fabricado en acero inoxidable AISI 304, 18/10.
Tubo rebosadero incluido.
Se entrega totalmente montado.

Made totally of Stainless steel AISI 304, 18/10.
Overflow tube included.
Delivered fully assembled.

Réalisées complètement en acier inoxydable AISI 304, 18/10.
Avec tube trop-plein.
Livrés entièrement assemblés.

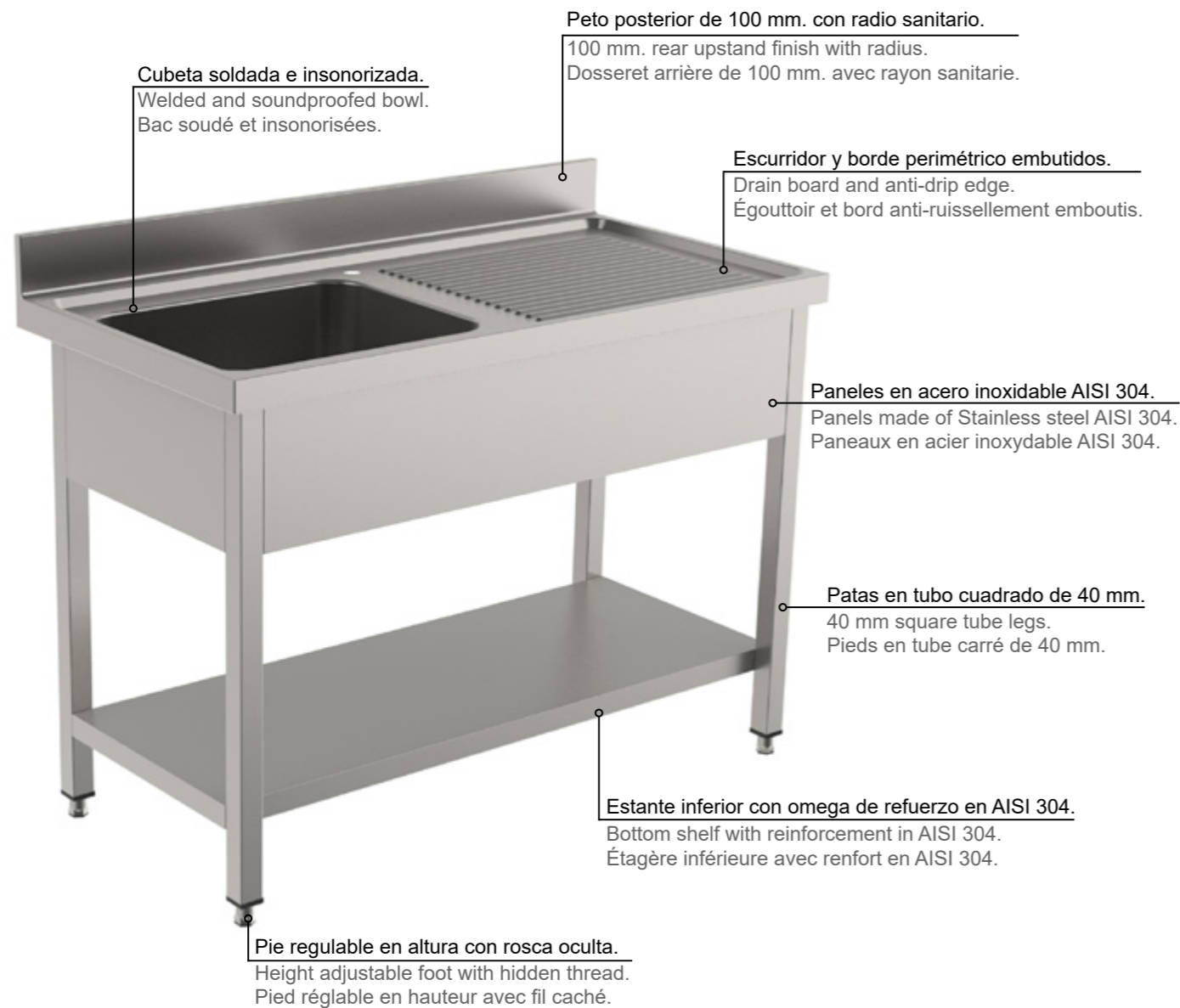

DIMENSIONES / DIMENSIONS

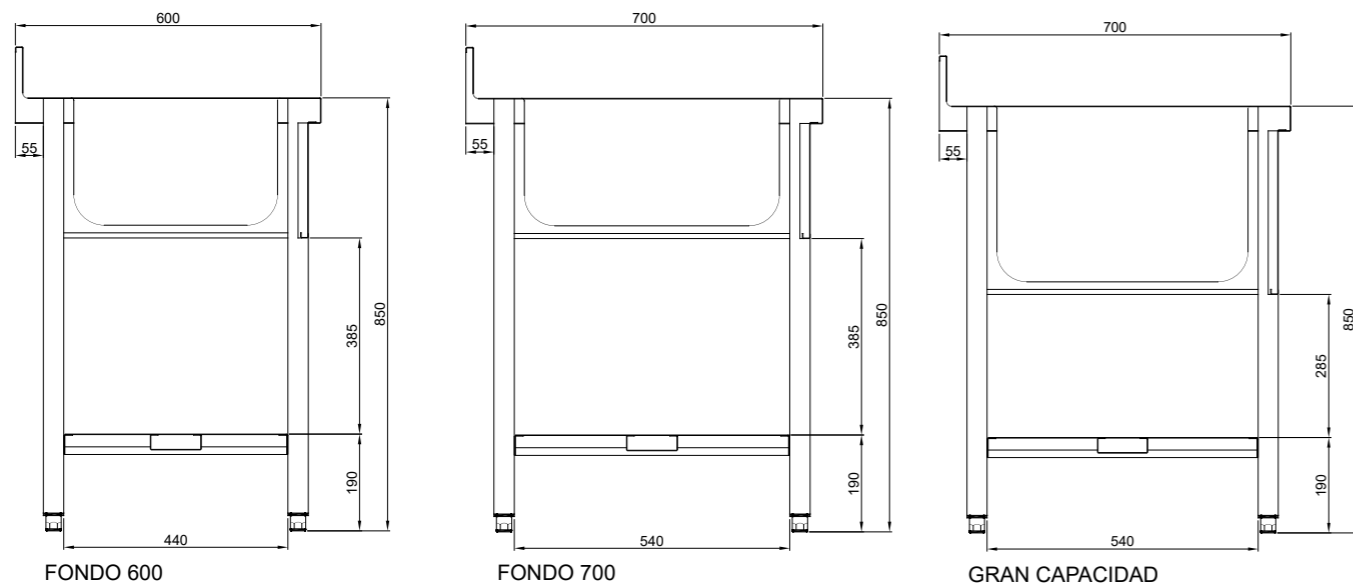

FREGADEROS GAMA 600 / 700

600/700 SINKS RANGE / EVIERS GAMME 600/700



FONDO 600

DIMENSIONES	DIM. CUBETA	CUBETAS	ESCURRIDOR	SIN ESTANTE		CON ESTANTE		
				CÓDIGO	PRECIO	CÓDIGO	PRECIO	
	600X600X850	400X400X250	1	NO	F0661	481 €	F0661E	575 €
	700X600X850	500X500X250			F0761	556 €	F0761E	669 €
	1000X600X850	400X400X250	1	DERECHO	F106D1	568 €	F106D1E	700 €
	1200X600X850	500X400X250			F126D1	617 €	F126D1E	752 €
	1300X600X850	500X400X250			F136D1	664 €	F136D1E	835 €
	1400X600X850	500X400X250			F146D1	758 €	F146D1E	930 €
	1000X600X850	400X400X250	1	IZQUIERDO	F106I1	568 €	F106I1E	705 €
	1200X600X850	500X400X250			F126I1	617 €	F126I1E	752 €
	1300X600X850	500X400X250			F136I1	664 €	F136I1E	835 €
	1400X600X850	500X400X250			F146I1	758 €	F146I1E	930 €
	1000X600X850	400X400X250	2	NO	F1062	734 €	F1062E	705 €
	1200X600X850	400X400X250			F1262	769 €	F1262E	914 €
	1400X600X850	500X400X250			F1462	899 €	F1462E	1.055 €
	1600X600X850	400X400X250	2	DERECHO	F146D2	810 €	F146D2E	988 €
	1800X600X850	500X400X250			F166D2	893 €	F166D2E	1.082 €
	1900X600X850	500X400X250			F186D2	963 €	F186D2E	1.156 €
	1400X600X850	400X400X250			F196D2	982 €	F196D2E	1.212 €
	1600X600X850	400X400X250	2	IZQUIERDO	F146I2	810 €	F146I2E	988 €
	1800X600X850	500X400X250			F166I2	893 €	F166I2E	1.082 €
	1900X600X850	500X400X250			F186I2	963 €	F186I2E	1.156 €
	1400X600X850	400X400X250			F196I2	982 €	F196I2E	1.212 €
	2100X600X850	500X400X250	2	2	F216ID2	1.180 €	F216ID2E	1.402 €

FONDO 700

DIMENSIONES	DIM. CUBETA	CUBETAS	ESCURRIDOR	SIN ESTANTE		CON ESTANTE		
				CÓDIGO	PRECIO	CÓDIGO	PRECIO	
	700X700X850	500X500X300	1	NO	F0771	643 €	F0771E	773 €
	800X700X850	600X500X300			F0871	695 €	F0871E	811 €
	1000X700X850	500X500X300	1	DERECHO	F107D1	674 €	F107D1E	831 €
	1200X700X850	500X500X300			F127D1	742 €	F127D1E	883 €
	1300X700X850	500X500X300			F137D1	789 €	F137D1E	956 €
	1400X700X850	600X500X300			F147D1	810 €	F147D1E	1.003 €
	1000X700X850	500X500X300	1	IZQUIERDO	F107I1	674 €	F107I1E	831 €
	1200X700X850	500X500X300			F127I1	742 €	F127I1E	883 €
	1300X700X850	500X500X300			F137I1	789 €	F137I1E	956 €
	1400X700X850	600X500X300			F147I1	810 €	F147I1E	1.003 €
	1000X700X850	400X500X300	2	NO	F1072	867 €	F1072E	992 €
	1200X700X850	500X500X300			F1272	930 €	F1272E	1.056 €
	1400X700X850	600X500X300			F1472	1.139 €	F1472E	1.259 €
	1600X700X850	400X500X300	2	DERECHO	F167D2	972 €	F167D2E	1.186 €
	1800X700X850	500X500X300			F187D2	1.043 €	F187D2E	1.280 €
	1900X700X850	600X500X300			F197D2	1.160 €	F197D2E	1.412 €
	2100X700X850	600X500X300			F217D2	1.385 €	F217D2E	1.566 €
	1600X700X850	400X500X300	2	IZQUIERDO	F167I2	972 €	F167I2E	1.186 €
	1800X700X850	500X500X300			F187I2	1.043 €	F187I2E	1.280 €
	1900X700X850	600X500X300			F197I2	1.160 €	F197I2E	1.412 €
	2100X700X850	600X500X300			F217I2	1.385 €	F217I2E	1.566 €
	2100X700X850	500X500X300	2	2	F217ID2	1.556 €	F217ID2E	1.662 €
	2400X700X850	600X500X300			F247ID2	1.457 €	F247ID2E	1.735 €

FREGADEROS DE GRAN CAPACIDAD

HIGH CAPACITY SINK / ÉVIERS GRANDE CAPACITÉ



	DIMENSIONES	DIM. CUBETA	CUBETAS	ESCURRIDOR	SIN ESTANTE		CON ESTANTE	
					CÓDIGO	PRECIO	CÓDIGO	PRECIO
	1000X700X850	800X500X350			FO1071	925 €	FO1071E	1.076 €
	1200X700X850	1060X500X350	1	NO	FO1271	1.024 €	FO1271E	1.193 €
	1400X700X850	1160X500X350			FO1471	1.155 €	FO1471E	1.338 €
	1600X700X850	800X510X350			FO167D1	1.181 €	FO167D1E	1.400 €
	1800X700X850	1160X500X350	1	DERECHO	FO187D1	1.264 €	FO187D1E	1.494 €
	2000X700X850	1160X500X350			FO207D1	1.348 €	FO207D1E	1.588 €
	1600X700X850	800X510X350			FO167I1	1.181 €	FO167I1E	1.400 €
	1800X700X850	1160X500X350	1	IZQUIERDO	FO187I1	1.264 €	FO187I1E	1.494 €
	2000X700X850	1160X500X350			FO207I1	1.348 €	FO207I1E	1.588 €
	1800X700X850	800X500X350	2	NO	FO1872	1.479 €	FO1872E	1.630 €
	2000X700X850	800X500X350			FO2172	1.839 €	FO2172E	2.006 €

FREGADEROS GAMA 550

550 SINKS RANGE / EVIERS GAMME 550



	DIMENSIONES	DIM. CUBETA	CUBETAS	ESCURRIDOR	SIN ESTANTE		CON ESTANTE	
					CÓDIGO	PRECIO	CÓDIGO	PRECIO
	1000X550X850	400X400X250			F1055D1	568 €	F1055D1E	700 €
	1200X550X850	500X400X250	1	DERECHO	F1255D1	617 €	F1255D1E	752 €
	1400X550X850	500X400X250			F1455D1	758 €	F1455D1E	930 €
	1000X550X850	400X400X250			F1055I1	568 €	F1055I1E	700 €
	1200X550X850	500X400X250	1	IZQUIERDO	F1255I1	617 €	F1255I1E	752 €
	1400X550X850	500X400X250			F1455I1	758 €	F1455I1E	930 €

Dimensiones en mm. Los precios indicados serán gravados con el I.V.A. correspondiente.

FREGADEROS PARA LAVAVAJILLAS

DISHWASHER SINKS / EVIERS POUR LAVE-VAISSELLE



Lavavajillas no incluido



	DIMENSIONES	DIM. CUBETA	CUBETAS	ESCURRIDOR	SIN ESTANTE		CON ESTANTE	
					CÓDIGO	PRECIO	CÓDIGO	PRECIO
	1200X550X850	400X400X250			FL125D1	486 €	FL125D1E	585 €
	1200X600X850	500X400X250	1	DERECHO	FL126D1	486 €	FL126D1E	585 €
	1200X700X850	500X500X300			FL127D1	579 €	FL127D1E	658 €
	1200X550X850	400X400X250			FL125I1	486 €	FL125I1E	585 €
	1200X600X850	500X400X250	1	IZQUIERDO	FL126I1	486 €	FL126I1E	585 €
	1200X700X850	500X500X300			FL127I1	579 €	FL127I1E	658 €
	1800X600X850	500X400X250	2	DERECHO	FL186D2	982 €	FL186D2E	1.097 €
	1800X700X850	500X500X300			FL187D2	1.035 €	FL187D2E	1.181 €
	1800X600X850	500X400X250	2	IZQUIERDO	FL186I2	982 €	FL186I2E	1.097 €
	1800X700X850	500X500X300			FL187I2	1.035 €	FL187I2E	1.181 €



Lavavajillas no incluido



	DIMENSIONES	DIM. CUBETA	CUBETAS	ESCURRIDOR	PUERTA ABATIBLE		PUERTA CORREDERA	
					CÓDIGO	PRECIO	CÓDIGO	PRECIO
	1200X550X850	400X400X250			FABL125D1	906 €	-	-
	1200X600X850	500X400X250	1	DERECHO	FABL126D1	916 €	-	-
	1200X700X850	500X500X250			FABL127D1	983 €	-	-
	1200X550X850	400X400X250			FABL125I1	906 €	-	-
	1200X600X850	500X400X250	1	IZQUIERDO	FABL126I1	916 €	-	-
	1200X700X850	500X500X300			FABL12I71	983 €	-	-
	1800X600X850	500X400X250	2	DERECHO	FABL186D2	1.565 €	FACL186D2	1.525 €
	1800X700X850	500X500X300			FABL187D2	1.693 €	FACL187D2	1.608 €
	1800X600X850	500X400X250	2	IZQUIERDO	FABL186I2	1.565 €	FACL186I2	1.525 €
	1800X700X850	500X500X300			FABL187I2	1.693 €	FACL187I2	1.608 €

FREGADEROS GAMA 500
500 SINK RANGE / EVIERS GAMME 500

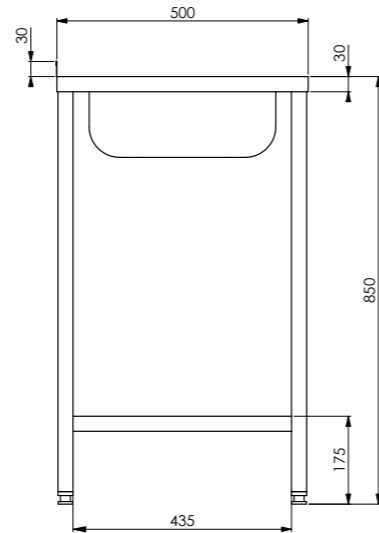

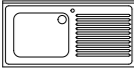
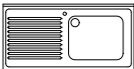
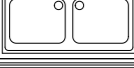
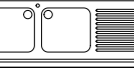
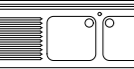
DIMENSIONES	DIM. CUBETA	CUBETAS	ESCURRIDOR	SIN ESTANTE		CON ESTANTE				
				CÓDIGO	PRECIO	CÓDIGO	PRECIO			
 800X500X850	340X365X150	1	DERECHO	F085D1	276 €	F085D1E	334 €			
900X500X850				F095D1	285 €	F095D1E	347 €			
1000X500X850				F105D1	294 €	F105D1E	356 €			
 800X500X850	340X365X150	1	IZQUIERDO	F085I1	276 €	F085I1E	334 €			
900X500X850				F095I1	285 €	F095I1E	347 €			
1000X500X850				F105I1	294 €	F105I1E	356 €			
 800X500X850	340X365X150	2	NO	F0852	297 €	F0852E	358 €			
 1200X500X850				340X365X150	2	DERECHO	F125D2	352 €	F125D2E	421 €
1350X500X850							F135D2	373 €	F135D2E	450 €
 1200X500X850	340X365X150	2	IZQUIERDO	F125I2	352 €	F125I2E	421 €			
1350X500X850				F135I2	373 €	F135I2E	450 €			

FREGADERO VERTEDERO
OUTLET SINK / ÉVIER DÉVERSOIR

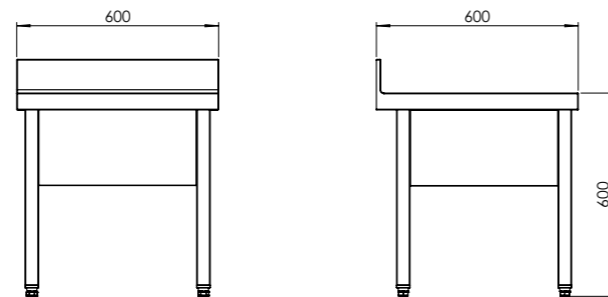

DIMENSIONES	DIM. CUBETA	CÓDIGO	PRECIO
600X600X500	400X400X250	F066V	543 €
700X600X500	500X500X250	F067V	619 €

FREGADEROS CON ARO DE DESBARACE
HASTE HOLE SINKS / EVIERS AVEC TROU VIDE DÉCHETS

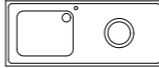
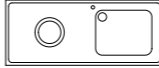

DIMENSIONES	DIM. CUBETA	CUBETAS	ARO	CÓDIGO	PRECIO
 1400X600X850	500X400X250	1	DERECHO	FD146D	810 €
1400X700X850	500X500X250			FD147D	857 €
 1400X600X850	500X400X250	1	IZQUIERDO	FD146I	810 €
1400X700X850	500X500X250			FD147I	857 €

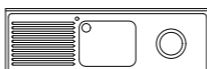
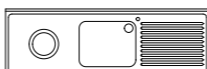

DIMENSIONES	DIM. CUBETA	CUBETAS	ARO	CON ESCURRIDOR		CON ESCURRIDOR	
				CÓDIGO	PRECIO	CÓDIGO	PRECIO
 1800X600X850	500X400X250	1	DERECHO	FD186D	1.108 €	FDL186D	1.066 €
1800X700X850	500X500X250			FD187D	1.233 €	FDL187D	1.129 €
 1800X600X850	500X400X250	1	IZQUIERDO	FD186I	1.108 €	FDL186I	1.066 €
1800X700X850	500X500X250			FD187I	1.233 €	FDL187I	1.129 €

FREGADEROS PARA VERDURAS
VEGETABLE SINKS / EVIERS DE PRÉPARATION DE LÉGUMES



DIMENSIONES	CÓDIGO	PRECIO
1200X600X850	FLV126	915 €
1400X600X850	FLV146	1.014 €
1800X600X850	FLV186	1.181 €

DIMENSIONES	CÓDIGO	PRECIO
1200X700X850	FLV127	1.021 €
1400X700X850	FLV147	1.120 €
1800X700X850	FLV187	1.287 €

FREGADEROS CON ARMARIO

SINKS WITH OVER CUPBOARD / EVIERS AVEC ARMOIRE

Totalmente fabricado en acero inoxidable AISI 304, 18/10.
Tubo rebosadero incluido.
Se entrega totalmente montado.

Made totally of Stainless steel AISI 304, 18/10
Overflow tube included.
Delivered fully assembled.

Réalisées complètement en acier inoxydable AISI 304, 18/10.
Avec tube trop-plein.
Livrés entièrement assemblés.

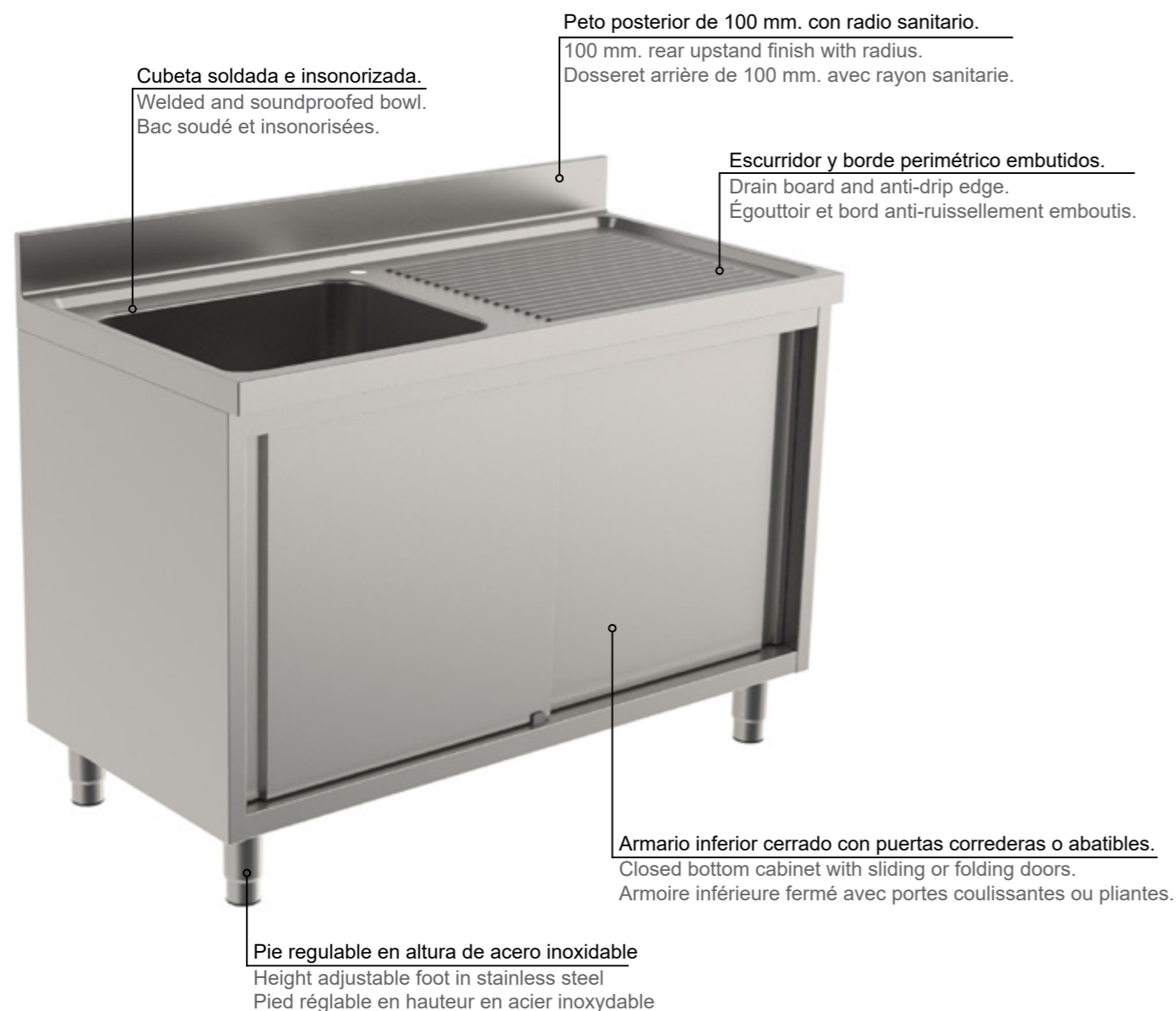

DIMENSIONES / DIMENSIONS

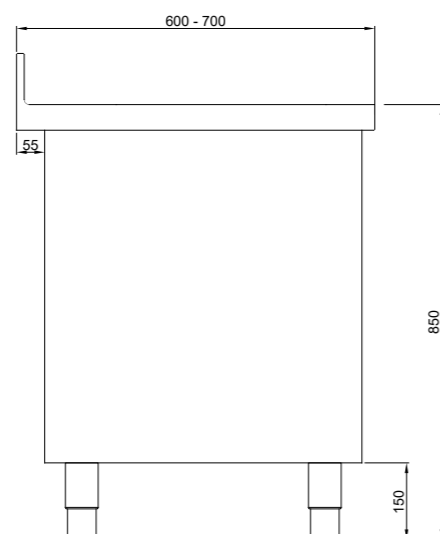

Dimensiones en mm. Los precios indicados serán gravados con el I.V.A. correspondiente.

FREGADEROS GAMA 600 / 700

600/700 SINKS RANGE / EVIERS GAMME 600/700



	DIMENSIONES	DIM. CUBETA	CUBETAS	ESCURRIDOR	PUERTA ABATIBLE		PUERTA CORREDERA	
					CÓDIGO	PRECIO	CÓDIGO	PRECIO
	600X600X850	400X400X250	1	NO	FA0661	1.001 €	-	-
	700X600X850	500X400X250			FA0761	1.077 €	-	-
	1000X600X850	400X400X250	1	DERECHO	FAB106D1	1.147 €	FAC106D1	1.218 €
	1200X600X850	500X400X250			FAB126D1	1.223 €	FAC126D1	1.229 €
	1400X600X850	500X400X250			FAB146D1	1.385 €	FAC146D1	1.488 €
	1000X600X850	400X400X250	1	IZQUIERDO	FAB106I1	1.147 €	FAC106I1	1.218 €
	1200X600X850	500X400X250			FAB126I1	1.223 €	FAC126I1	1.229 €
	1400X600X850	500X400X250			FAB146I1	1.385 €	FAC146I1	1.488 €
	1000X600X850	400X400X250	2	NO	FAB1062	1.329 €	FAC1062	1.392 €
	1200X600X850	500X400X250			FAB1262	1.408 €	FAC1262	1.477 €
	1400X600X850	500X400X250			FAB1462	1.591 €	FAC1462	1.566 €
	1400X600X850	400X400X250	2	DERECHO	FAB146D2	1.479 €	FAC146D2	1.538 €
	1600X600X850	400X400X250			FAB166D2	1.585 €	FAC166D2	1.648 €
	1800X600X850	500X400X250			FAB186D2	1.676 €	FAC186D2	1.742 €
	1400X600X850	400X400X250	2	IZQUIERDO	FAB146I2	1.479 €	FAC146I2	1.538 €
	1600X600X850	400X400X250			FAB166I2	1.585 €	FAC166I2	1.648 €
	1800X600X850	500X400X250			FAB186I2	1.676 €	FAC186I2	1.742 €



	DIMENSIONES	DIM. CUBETA	CUBETAS	ESCURRIDOR	PUERTA ABATIBLE		PUERTA CORREDERA	
					CÓDIGO	PRECIO	CÓDIGO	PRECIO
	600X700X850	500X500X300	1	NO	FA0771	1.128 €	-	-
	800X700X850	600X500X300			FA0871	1.207 €	-	-
	1000X700X850	500X500X300	1	DERECHO	FAB107D1	1.265 €	FAC107D1	1.301 €
	1200X700X850	500X500X300			FAB127D1	1.340 €	FAC127D1	1.315 €
	1400X700X850	600X500X300			FAB147D1	1.459 €	FAC147D1	1.535 €
	1000X700X850	500X500X300	1	IZQUIERDO	FAB107I1	1.265 €	FAC107I1	1.301 €
	1200X700X850	500X500X300			FAB127I1	1.340 €	FAC127I1	1.315 €
	1400X700X850	600X500X300			FAB147I1	1.459 €	FAC147I1	1.535 €
	1000X700X850	500X500X300	2	NO	FAB1072	1.441 €	FAC1072	1.489 €
	1200X700X850	500X500X300			FAB1272	1.539 €	FAC1272	1.582 €
	1400X700X850	500X500X300			FAB1472	1.839 €	FAC1472	1.668 €
	1400X700X850	500X500X300	2	DERECHO	FAB147D2	1.577 €	FAC147D2	1.701 €
	1600X700X850	500X500X300			FAB167D2	1.703 €	FAC167D2	1.755 €
	1800X700X850	500X500X300			FAB187D2	1.815 €	FAC187D2	1.830 €
	1400X700X850	500X500X300	2	IZQUIERDO	FAB147I2	1.577 €	FAC147I2	1.701 €
	1600X700X850	500X500X300			FAB167I2	1.703 €	FAC167I2	1.755 €
	1800X700X850	500X500X300			FAB187I2	1.815 €	FAC187I2	1.830 €

ENCIMERAS PARA FREGADEROS

SINK WORK TOP / PLAN DE TRAVAIL POR ÉVIERS

GAMA 500 / 500 RANGE / GAMME 500



	DIMENSIONES	DIM. CUBETA	CUBETAS	ESCURRIDOR	CÓDIGO	PRECIO
	800X500	340X365X150	1	DERECHO	F085D1T	110 €
	900X500				F095D1T	119 €
	1000X500				F105D1T	127 €
	800X500	340X365X150	1	IZQUIERDO	F085I1T	110 €
	900X500				F095I1T	119 €
	1000X500				F105I1T	127 €
	800X500	340X365X150	2	NO	F0852T	125 €
	1200X500	340X365X150	2	DERECHO	F125D2T	172 €
	1350X500				F135D2T	189 €
	1200X500	340X365X150	2	IZQUIERDO	F125I2T	172 €
	1350X500				F135I2T	189 €

GAMA 550 / 550 RANGE / GAMME 550



	DIMENSIONES	DIM. CUBETA	CUBETAS	ESCURRIDOR	CÓDIGO	PRECIO
	1000X550	400X400X250	1	DERECHO	F1055D1T	342 €
	1200X550	500X400X250			F1255D1T	400 €
	1400X550	500X400X250			F1455D1T	534 €
	1000X550	400X400X250	1	IZQUIERDO	F1055I1T	342 €
	1200X550	500X400X250			F1255I1T	400 €
	1400X550	500X400X250			F1455I1T	534 €

LAVADO VERDURAS / VEGETABLE WORK TOP / PRÉPARATION DE LÉGUMES

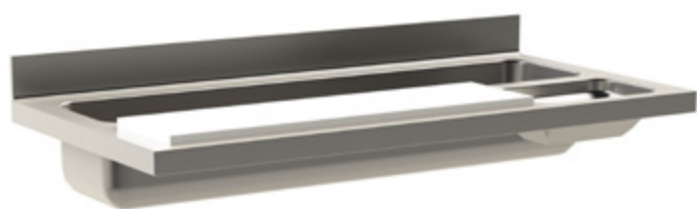

DIMENSIONES	CÓDIGO	PRECIO
1200X600	FLV126T	429 €
1400X600	FLV146T	454 €
1800X600	FLV186T	536 €

DIMENSIONES	CÓDIGO	PRECIO
1200X700	FLV127T	479 €
1400X700	FLV147T	504 €
1800X700	FLV187T	586 €

Dimensiones en mm. Los precios indicados serán gravados con el I.V.A. correspondiente.

GAMA 600-700 / 600-700 RANGE / GAMME 600-700



	DIMENSIONES	DIM. CUBETA	CUBETAS	ESCURRIDOR	CÓDIGO	PRECIO
	600X600	400X400X250	1	NO	F0661T	300 €
	700X600	500X500X250			F0771T	344 €
	1000X600	400X400X250	1	DERECHO	F106D1T	347 €
	1200X600	500X400X250			F126D1T	402 €
	1300X600	500X400X250			F136D1T	429 €
	1400X600	500X400X250			F146D1T	534 €
	1000X600	400X400X250			F106I1T	347 €
	1200X600	500X400X250	1	IZQUIERDO	F126I1T	402 €
	1300X600	500X400X250			F136I1T	429 €
	1400X600	500X400X250			F146I1T	534 €
	1000X600	400X400X250			F1062T	510 €
	1200X600	400X400X250	2	NO	F1262T	530 €
	1400X600	500X400X250			F1462T	549 €
	1400X600	400X400X250			F146D2T	534 €
	1600X600	400X400X250			F166D2T	583 €
	1800X600	500X400X250			F186D2T	612 €
	1900X600	500X400X250	2	DERECHO	F196D2T	667 €
	1400X600	400X400X250			F146I2T	534 €
	1600X600	400X400X250			F166I2T	583 €
	1800X600	500X400X250			F186I2T	612 €
	1900X600	500X400X250	2	IZQUIERDO	F196I2T	667 €
	2100X600	500X400X250			F216I2T	694 €

	DIMENSIONES	DIM. CUBETA	CUBETAS	ESCURRIDOR	CÓDIGO	PRECIO
	700X700	500X500X300	1	NO	F0771T	365 €
	800X700	600X500X300			F0871T	466 €
	1000X700	500X500X300	1	DERECHO	F107D1T	423 €
	1200X700	500X500X300			F127D1T	464 €
	1300X700	500X500X300			F137D1T	487 €
	1400X700	600X500X300			F147D1T	526 €
	1000X700	500X500X300			F107I1T	423 €
	1200X700	500X500X300	1	IZQUIERDO	F127I1T	464 €
	1300X700	500X500X300			F137I1T	487 €
	1400X700	600X500X300			F147I1T	526 €
	1000X700	400X500X300			F1072T	595 €
	1200X700	500X500X300	2	NO	F1272T	626 €
	1400X700	600X500X300			F1472T	849 €
	1600X700	400X500X300			F167D2T	677 €
	1800X700	500X500X300	2	DERECHO	F187D2T	689 €
	1900X700	600X500X300			F197D2T	820 €
	2100X700	600X500X300			F217D2T	979 €
	1600X700	400X500X300			F167I2T	677 €
	1800X700	500X500X300			F187I2T	689 €
	1900X700	600X500X300	2	IZQUIERDO	F197I2T	820 €
	2100X700	600X500X300			F217I2T	979 €
	2100X700	500X500X300			F217ID2T	873 €
	2400X700	600X500X300			F247ID2T	971 €

ENCIMERAS PARA FREGADEROS

SINK WORK TOP / PLAN DE TRAVAIL POR ÉVIERS

GAMA 500 / 500 RANGE / GAMME 500



	DIMENSIONES	DIM. CUBETA	CUBETAS	ARO	CÓDIGO	PRECIO
	1400X600	500X400X250	1	DERECHO	FD146DT	540 €
	1400X700	500X500X300			FD147DT	565 €
	1400X600	500X400X250	1	IZQUIERDO	FD146IT	540 €
	1400X700	500X500X300			FD147IT	565 €



	DIMENSIONES	DIM. CUBETA	CUBETAS	ARO	CÓDIGO	PRECIO
	1800X600	500X400X250	1	DERECHO	FD186DT	750 €
	1800X700	500X500X300			FD187DT	796 €
	1800X600	500X400X250	1	IZQUIERDO	FD186IT	750 €
	1800X700	500X500X300			FD187IT	796 €

ENCIMERAS GRAN CAPACIDAD / HIGH CAPACITY / GRANDE CAPACITÉ



	DIMENSIONES	DIM. CUBETA	CUBETAS	ESCURRIDOR	CÓDIGO	PRECIO
	1000X700	800X500X350	1	NO	FO1071T	629 €
	1200X700	1060X500X350			FO1271T	757 €
	1400X700	1160X500X350			FO1471T	767 €
	1600X700	800X510X350	1	DERECHO	FO167D1T	803 €
	1800X700	1160X500X350			FO187D1T	847 €
	2000X700	1160X500X350			FO207D1T	926 €
	1600X700	800X510X350	1	IZQUIERDO	FO167I1T	803 €
	1800X700	1160X500X350			FO187I1T	847 €
	2000X700	1160X500X350			FO207I1T	926 €
	1800X700	800X500X350	2	NO	FO1872T	899 €
	2000X700	800X500X350			FO2172T	1.020 €

Dimensiones en mm. Los precios indicados serán gravados con el I.V.A. correspondiente.

ACCESORIOS PARA FREGADEROS

SINK ACCESSORIES / ACCESSOIRES POUR ÉVIER

SOPORTES PARA FREGADEROS / SINK SUPPORT / SUPPORT POUR ÉVIERS



Encimera no incluida



FONDO FREGADERO	CÓDIGO	PRECIO	CÓDIGO	PRECIO
600	SPMF06	152 €	SPMF06P	161 €
700	SPMF07	156 €	SPMF07P	168 €

PETO LATERAL PARA FREGADEROS / TOP SIDE SINK PANEL / DOSSERET POUR ÉVIERS



FONDO FREGADERO	LADO FREGADERO	CÓDIGO	PRECIO
600	DERECHO	ALZD06	121 €
700		ALZD07	131 €
600	IZQUIERDO	ALZI06	121 €
700		ALZI07	131 €

ESTANTE INFERIOR / LOWER SHELF / ETAGÈRE



DIMENSIONES	CÓDIGO	PRECIO
600X600	ENT066	97 €
700X600	ENT076	102 €
1000X600	ENT106	137 €
1200X600	ENT126	146 €
1300X600	ENT136	154 €
1400X600	ENT146	166 €
1600X600	ENT166	175 €
1800X600	ENT186	241 €
1900X600	ENT196	249 €
2100X600	ENT216	259 €

DIMENSIONES	CÓDIGO	PRECIO
700X700	ENT077	114 €
800X700	ENT087	137 €
1000X700	ENT107	149 €
1200X700	ENT127	172 €
1300X700	ENT137	183 €
1400X700	ENT147	190 €
1600X700	ENT167	200 €
1800X700	ENT187	236 €
1900X700	ENT197	280 €
2100X700	ENT217	300 €
2400X700	ENT247	320 €

GRIFERÍA
TAPS / ROBINETS

GRIFERÍA

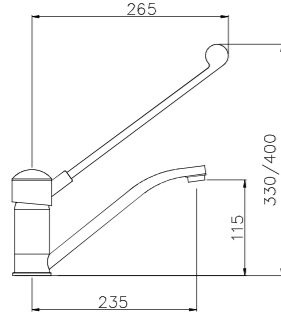

CÓDIGO	PRECIO
GE01	150 €

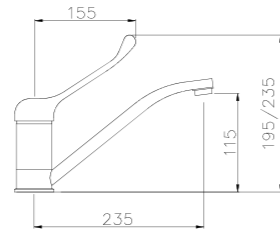

CÓDIGO	PRECIO
GE02	78 €

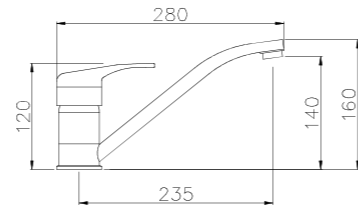

CÓDIGO	PRECIO
GE03	78 €

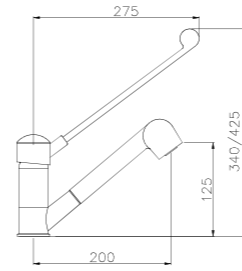

CÓDIGO	PRECIO
GE04	145 €

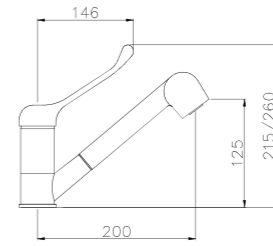

CÓDIGO	PRECIO
GE05	143 €

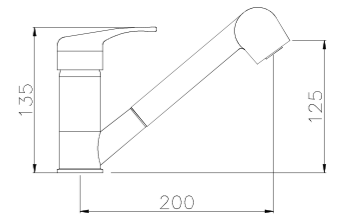

CÓDIGO	PRECIO
GE06	143 €

GRIFERÍA
TAPS / ROBINETS

GRIFERÍA

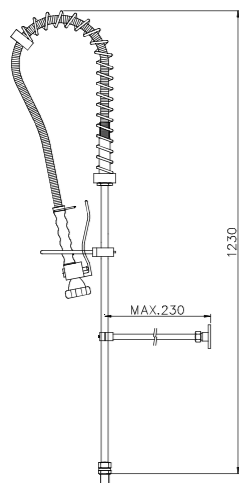

CÓDIGO	PRECIO
GD01	306 €

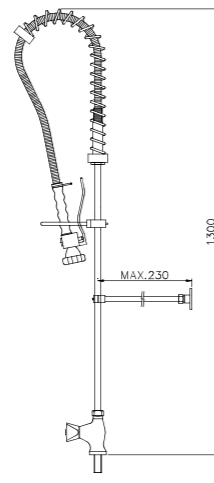

CÓDIGO	PRECIO
GD02	266 €

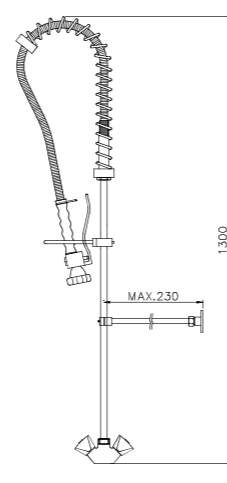

CÓDIGO	PRECIO
GD03	347 €

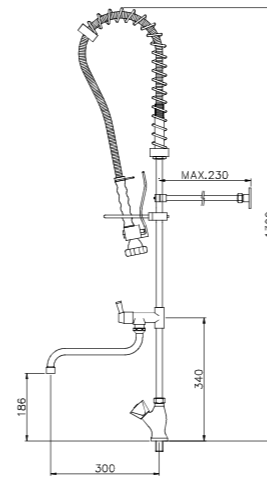

CÓDIGO	PRECIO
GD04	368 €

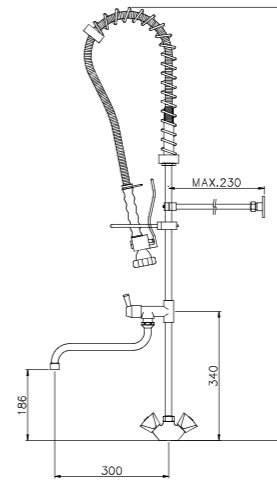

CÓDIGO	PRECIO
GD05	349 €

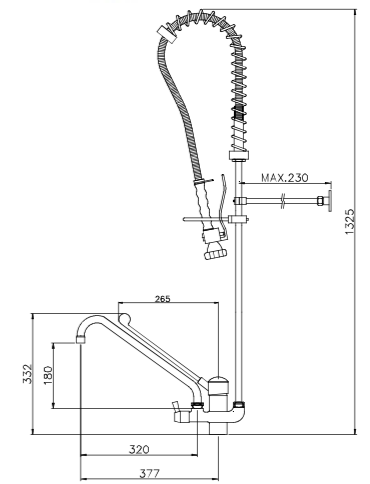

CÓDIGO	PRECIO
GD06	440 €

A-CERINOX

A-CERINOX

LAVAMANOS DE PIE
HANDWASH BASIN / LAVE-MAINS



Pulsador simple

DIMENSIONES	CÓDIGO	PRECIO
450X450X850	LAVPPUL1	387 €



Pulsador doble

DIMENSIONES	CÓDIGO	PRECIO
450X450X850	LAVPPUL2	432 €



Pedal simple

DIMENSIONES	CÓDIGO	PRECIO
450X450X850	LAVPPED1	523 €



Pedal doble

DIMENSIONES	CÓDIGO	PRECIO
450X450X850	LAVPPED2	579 €



Con grifo electrónico

DIMENSIONES	CÓDIGO	PRECIO
450X450X850	LAVPFOT	722 €

LAVAMANOS MURAL
WALL HANDWASH / LAVE-MAINS MURAL

Construcción

- Fabricado totalmente en acero inoxidable **AISI 304, 18/10**.
- Cubeta estampada con reborde perimétrico.
- Caño giratorio cromado.
- Latiguillos de conexión incluidos.

Features

- Made totally of Stainless steel **AISI 304, 18/10**.
- Stamped tray with perimeter rim.
- Chrome swivel spout.
- Connection cables included.

Construcción

- Réalisées complètement en acier inoxydable **AISI 304, 18/10**.
- Plateau estampé avec rebord périphérique.
- Bec pivotant chromé.
- Câbles de connexion inclus.



DIMENSIONES	CÓDIGO	PRECIO
400X330X230	LAVMPUL1	225 €



DIMENSIONES	CÓDIGO	PRECIO
450X450X300	LAVMPUL2	234 €



Pedal simple

DIMENSIONES	CÓDIGO	PRECIO
450X450X300	LAVMPED1	356 €



Pedal doble

DIMENSIONES	CÓDIGO	PRECIO
450X450X300	LAVMPED2	423 €



Con grifo electrónico

DIMENSIONES	CÓDIGO	PRECIO
450X450X300	LAVMFOT	648 €

MESAS PARA LAVAVAJILLAS

DISHWASHER TABLES / TABLES DE LAVE-VAISSELLE



MESAS PARA LAVAVAJILLAS

DISHWASHER TABLES / TABLES DE LAVE-VAISSELLE

MESAS CENTRALES SIN CUBA



DIMENSIONES	SIN ESTANTE		CON ESTANTE	
	CÓDIGO	PRECIO	CÓDIGO	PRECIO
700X610X850	ML07CB	490 €	ML07CE	570 €
1100X610X850	ML11CB	579 €	ML11CE	623 €
1600X610X850	ML16CB	657 €	ML16CE	716 €
2100X610X850	ML21CB	726 €	ML21CE	805 €

MESAS MURALES SIN CUBA



DIMENSIONES	SIN ESTANTE		CON ESTANTE		SIN ESTANTE		CON ESTANTE	
	CÓDIGO	PRECIO	CÓDIGO	PRECIO	CÓDIGO	PRECIO	CÓDIGO	PRECIO
700X750X850	ML07MBD	568 €	ML07MED	649 €	ML07MBI	568 €	ML07MEI	649 €
1100X750X850	ML11MBD	660 €	ML11MED	708 €	ML11MBI	660 €	ML11MEI	708 €
1600X750X850	ML16MBD	770 €	ML16MED	825 €	ML16MBI	770 €	ML16MEI	825 €
2100X750X850	ML21MBD	838 €	ML21MED	915 €	ML21MBI	838 €	ML21MEI	915 €

MESAS MURALES CON CUBA



DIMENSIONES	SIN ESTANTE		CON ESTANTE		SIN ESTANTE		CON ESTANTE	
	CÓDIGO	PRECIO	CÓDIGO	PRECIO	CÓDIGO	PRECIO	CÓDIGO	PRECIO
1100X750X850	ML11SBD	955 €	ML11SED	1.022 €	ML11SBI	955 €	ML11SEI	1.022 €
1600X750X850	ML16SBD	1.093 €	ML16SED	1.159 €	ML16SBI	1.093 €	ML16SEI	1.159 €
2100X750X850	ML21SBD	1.166 €	ML21SED	1.233 €	ML21SBI	1.166 €	ML21SEI	1.233 €

MESAS MURALES CON CUBA Y ARO DE GOMA



DIMENSIONES	SIN ESTANTE		CON ESTANTE		SIN ESTANTE		CON ESTANTE	
	CÓDIGO	PRECIO	CÓDIGO	PRECIO	CÓDIGO	PRECIO	CÓDIGO	PRECIO
1600X750X850	ML16SABD	1.294 €	ML16SAED	1.385 €	ML16SABI	1.294 €	ML16SAEI	1.385 €
2100X750X850	ML21SABD	1.409 €	ML21SAED	1.476 €	ML21SABI	1.409 €	ML21SAEI	1.476 €

MESAS PARA LAVAVAJILLAS

DISHWASHER TABLES / TABLES DE LAVE-VAISSELLE

MESAS DE RODILLOS

ROLLER TABLES / TABLES À ROULEAUX

**MESAS CENTRALES CON RODILLOS**

SIN ESTANTE



CON ESTANTE

DIMENSIONES	CÓDIGO	PRECIO	CÓDIGO	PRECIO
1100X750X850	ML11CBR	1.071 €	ML11CER	1.113 €
1600X750X850	ML16CBR	1.145 €	ML16CER	1.200 €
2100X750X850	ML21CBR	1.210 €	ML21CER	1.284 €

MESAS MURALES CON RODILLOS

SIN ESTANTE



CON ESTANTE



SIN ESTANTE



CON ESTANTE

DIMENSIONES	CÓDIGO	PRECIO	CÓDIGO	PRECIO	CÓDIGO	PRECIO	CÓDIGO	PRECIO
1100X750X850	ML11MBDR	1.148 €	ML11MEDR	1.193 €	ML11MBIR	1.148 €	ML11MEIR	1.193 €
1600X750X850	ML16MBDR	1.252 €	ML16MEDR	1.303 €	ML16MBIR	1.252 €	ML16MEIR	1.303 €
2100X750X850	ML21MBDR	1.316 €	ML21MEDR	1.388 €	ML21MBIR	1.316 €	ML21MEIR	1.388 €

SOPORTE CESTAS

BASKET SUPPORT / SUPPORT DE PANIER

BANCADAS

SUPPORT



DIMENSIONES	CÓDIGO	PRECIO
550X550X610	BASCES	392 €



DIMENSIONES	CÓDIGO	PRECIO
450X450X150	BANC44	294 €
450X600X150	BANC46	298 €
600X600X150	BANC66	307 €

MESAS PARA LAVAVAJILLAS

DISHWASHER TABLES / TABLES DE LAVE-VAISSELLE

MESAS DE RECEPCIÓN DE SUCIO

RECEPTION TABLE / TABLE DE RÉCEPTION



Totalmente fabricado en acero inoxidable AISI 304, 18/10.
Tubo rebosadero incluido.
Se entrega totalmente montado.

Made totally of Stainless steel AISI 304, 18/10.
Overflow tube included.
Delivered fully assembled.

Réalisées complètement en acier inoxydable AISI 304, 18/10.
Avec tube trop-plein.
Livrés entièrement assemblés.



DIMENSIONES	CÓDIGO	PRECIO
700X500	EM075C	336 €
1100X500	EM115C	424 €
1600X500	EM165C	483 €



DIMENSIONES	CÓDIGO	PRECIO
1100X500X500	EC11LAV	595 €
1600X500X500	EC16LAV	623 €
2100X500X500	EC21LAV	719 €



SIN ESTANTE



SIN ESTANTE



CON ESTANTE



CON ESTANTE

DIMENSIONES	CÓDIGO	PRECIO	CÓDIGO	PRECIO	CÓDIGO	PRECIO	CÓDIGO	PRECIO
1100X800X850	MRS11BD	1.094 €	MRS11BI	1.094 €	MRS11ED	1.290 €	MRS11EI	1.290 €
1600X800X850	MRS16BD	1.167 €	MRS16BI	1.167 €	MRS16ED	1.408 €	MRS16EI	1.408 €
2100X800X850	MRS21BD	1.351 €	MRS21BI	1.351 €	MRS21ED	1.635 €	MRS21EI	1.635 €

Mesas y armarios.

Tables and cabinets. / Tables et armoires.

	pág.
MESAS DE TRABAJO / WORK TABLE / TABLE DE TRAVAIL	48
MESAS DE TRABAJO CON CUBETA / WORK TABLE RANGE WITH BOWL / TABLE DE TRAVAIL AVEC BAC	52
MESAS SOPORTE PARA HORNOS / SUPPORT FOR OVEN / SOUTIEN POUR FOUR	54
ESTANTE INFERIOR / LOWER SHELF / ETAGÈRE	54
CAJÓN SIMPLE / SINGLE DRAWER / TIROIR SIMPLE	55
CAJONERA / DRAWER UNIT / BLOC-TIROIRS	55
SOPORTE PARA BANDEJAS / TRAY SUPPORT / SUPPORT POUR BACS	55
PETO LATERAL / SIDE TOP PANEL/ DOSSERET LATÉRA	56
PANEL LATERAL / SIDE TABLE PANEL/ PANNEAU LATÉRAL	56
PUERTA PARA ARO DE DESBARACE / DOOR WASTE ZONE / PORTE POUR ZONE DE DÉCHETS	56
SOPORTES PARA ENCIMERAS / SUPPORTS FOR WORKTOP / SUPPORTS POUR PLAN DE TRAVAIL	57
KIT DE RUEDAS PARA MESAS / WHEEL KIT FOR TABLES / KIT DE ROUES POUR TABLES	57
MESA ARMARIO NEUTRO / TABLE WITH NEUTRAL CABINET / TABLE AVEC ARMOIRE NEUTRE	58
MESAS CON ARMARIO NEUTRO Y CAJONES / TABLES WITH NEUTRAL CABINET AND DRAWERS / TABLES AVEC ARMOIRE NEUTRE ET TIROIRS	60
MESAS CALIENTES / HOT TABLES / TABLES CHAUDES	61
ESTANTES DE SOBREMESA / TABLES OVER SHELF / ETAGERE SUR TABLE	62
ESTANTES SUSPENDIDOS / HANGING SHELVES / ÉTAGÈRES SUSPENDUES	62
ELEMENTO CALEFACTOR PARA ESTANTES DE SOBREMESA / HEATING ELEMENT FOR SHELF / ELEMENT DE CHAUFAGE POR ETAGERE	63
ARMARIO CALIENTA PLATOS / HEATER CABINET / CABINET DE CHAUFAGE	63
MUEBLE CAFETERO / CUPBOARD FOR COFFEE MACHINE / CABINET POUR MACHINE A CAFE	64
ARMARIOS DE PARED / WALL CABINET / ARMOIRE MURALE	65
ARMARIOS PARA VAJILLA / CABINETS FOR DISHES / ARMOIRES POUR LA VAISSELLE	67
ARMARIOS PARA PRODUCTOS DE LIMPIEZA / CABINETS FOR CLEANING PRODUCTS / ARMOIRES POUR PRODUITS DE NETTOYAGE	67



MESAS DE TRABAJO

WORK TABLE / TABLE DE TRAVAIL

Totalmente fabricado en acero inoxidable AISI 304, 18/10.
Se entrega totalmente montado.

Made totally of Stainless steel AISI 304, 18/10
Delivered full assembled.

Réalisées complètement en acier inoxydable AISI 304, 18/10.
Livrés entièrement assemblés.



DIMENSIONES / DIMENSIONS

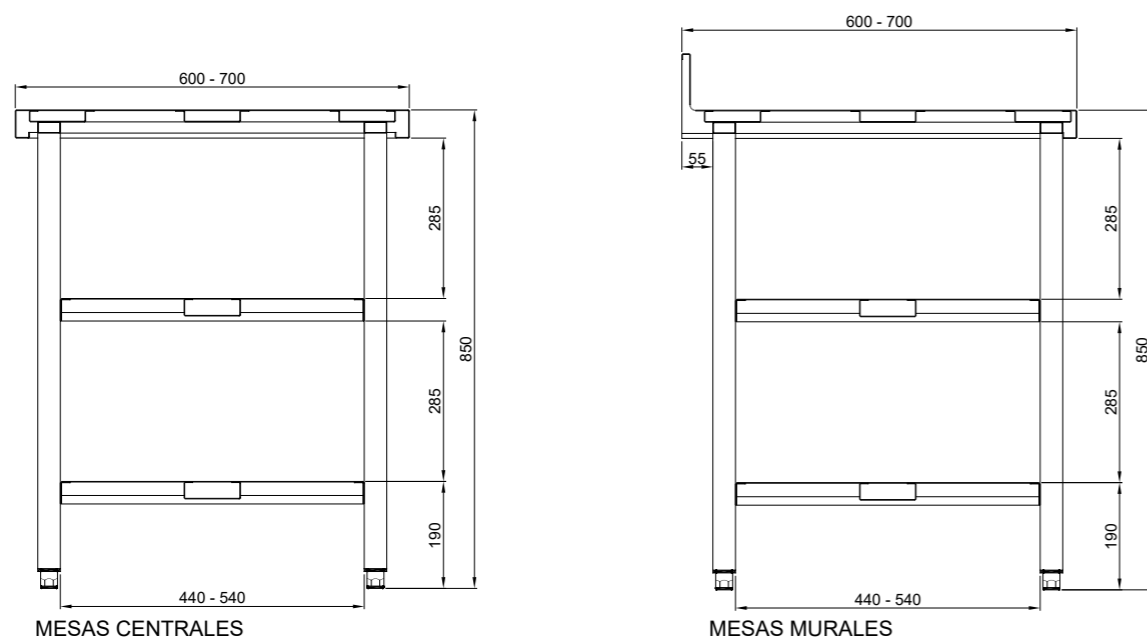

Dimensiones en mm. Los precios indicados serán gravados con el I.V.A. correspondiente.

CENTRAL

Fondo 600

DIMENSIONES	CON ESTANTE		CON 2 ESTANTES		SIN ESTANTE	
	CÓDIGO	PRECIO	CÓDIGO	PRECIO	CÓDIGO	PRECIO
600X600X850	M066C	458 €	M066CE	552 €	M066CB	421 €
800X600X850	M086C	485 €	M086CE	595 €	M086CB	441 €
1000X600X850	M106C	509 €	M106CE	641 €	M106CB	468 €
1200X600X850	M126C	525 €	M126CE	671 €	M126CB	485 €
1400X600X850	M146C	572 €	M146CE	741 €	M146CB	520 €
1500X600X850	M156C	593 €	M156CE	771 €	M156CB	530 €
1600X600X850	M166C	612 €	M166CE	792 €	M166CB	556 €
1800X600X850	M186C	664 €	M186CE	869 €	M186CB	578 €
2000X600X850	M206C	712 €	M206CE	928 €	M206CB	640 €
2200X600X850	M226C	851 €	M226CE	1.074 €	M226CB	777 €
2400X600X850	M246C	872 €	M246CE	1.116 €	M246CB	790 €

Fondo 700

DIMENSIONES	CON ESTANTE		CON 2 ESTANTES		SIN ESTANTE	
	CÓDIGO	PRECIO	CÓDIGO	PRECIO	CÓDIGO	PRECIO
600X700X850	M067C	486 €	M067CE	580 €	M067CB	444 €
800X700X850	M087C	508 €	M087CE	641 €	M087CB	475 €
1000X700X850	M107C	538 €	M107CE	693 €	M107CB	498 €
1200X700X850	M127C	554 €	M127CE	729 €	M127CB	520 €
1400X700X850	M147C	630 €	M147CE	822 €	M147CB	558 €
1500X700X850	M157C	645 €	M157CE	856 €	M157CB	569 €
1600X700X850	M167C	658 €	M167CE	882 €	M167CB	597 €
1800X700X850	M187C	710 €	M187CE	969 €	M187CB	624 €
2000X700X850	M207C	769 €	M207CE	1.037 €	M207CB	690 €
2200X700X850	M227C	897 €	M227CE	1.189 €	M227CB	835 €
2400X700X850	M247C	924 €	M247CE	1.237 €	M247CB	852 €

MURAL

Fondo 600

DIMENSIONES	CON ESTANTE		CON 2 ESTANTES		SIN ESTANTE	
	CÓDIGO	PRECIO	CÓDIGO	PRECIO	CÓDIGO	PRECIO
600X600X850	M066M	462 €	M066ME	556 €	M066MB	425 €
800X600X850	M086M	490 €	M086ME	600 €	M086MB	446 €
1000X600X850	M106M	514 €	M106ME	646 €	M106MB	472 €
1200X600X850	M126M	536 €	M126ME	682 €	M126MB	495 €
1400X600X850	M146M	580 €	M146ME	749 €	M146MB	528 €
1500X600X850	M156M	606 €	M156ME	784 €	M156MB	543 €
1600X600X850	M166M	624 €	M166ME	805 €	M166MB	569 €
1800X600X850	M186M	702 €	M186ME	907 €	M186MB	616 €
2000X600X850	M206M	745 €	M206ME	961 €	M206MB	674 €
2200X600X850	M226M	922 €	M226ME	1.145 €	M226MB	848 €
2400X600X850	M246M	961 €	M246ME	1.205 €	M246MB	878 €

Fondo 700

DIMENSIONES	CON ESTANTE		CON 2 ESTANTES		SIN ESTANTE	
	CÓDIGO	PRECIO	CÓDIGO	PRECIO	CÓDIGO	PRECIO
600X700X850	M067M	491 €	M067ME	585 €	M067MB	448 €
800X700X850	M087M	500 €	M087ME	645 €	M087MB	478 €
1000X700X850	M107M	533 €	M107ME	695 €	M107MB	501 €
1200X700X850	M127M	560 €	M127ME	735 €	M127MB	525 €
1400X700X850	M147M	608 €	M147ME	826 €	M147MB	570 €
1500X700X850	M157M	679 €	M157ME	891 €	M157MB	603 €
1600X700X850	M167M	697 €	M167ME	921 €	M167MB	636 €
1800X700X850	M187M	738 €	M187ME	997 €	M187MB	652 €
2000X700X850	M207M	794 €	M207ME	1.062 €	M207MB	715 €
2200X700X850	M227M	969 €	M227ME	1.208 €	M227MB	861 €
2400X700X850	M247M	1.007 €	M247ME	1.271 €	M247MB	935 €

MESAS DE TRABAJO FONDO 500

500 WORK TABLE RANGE / TABLE DE TRAVAIL GAMME 500

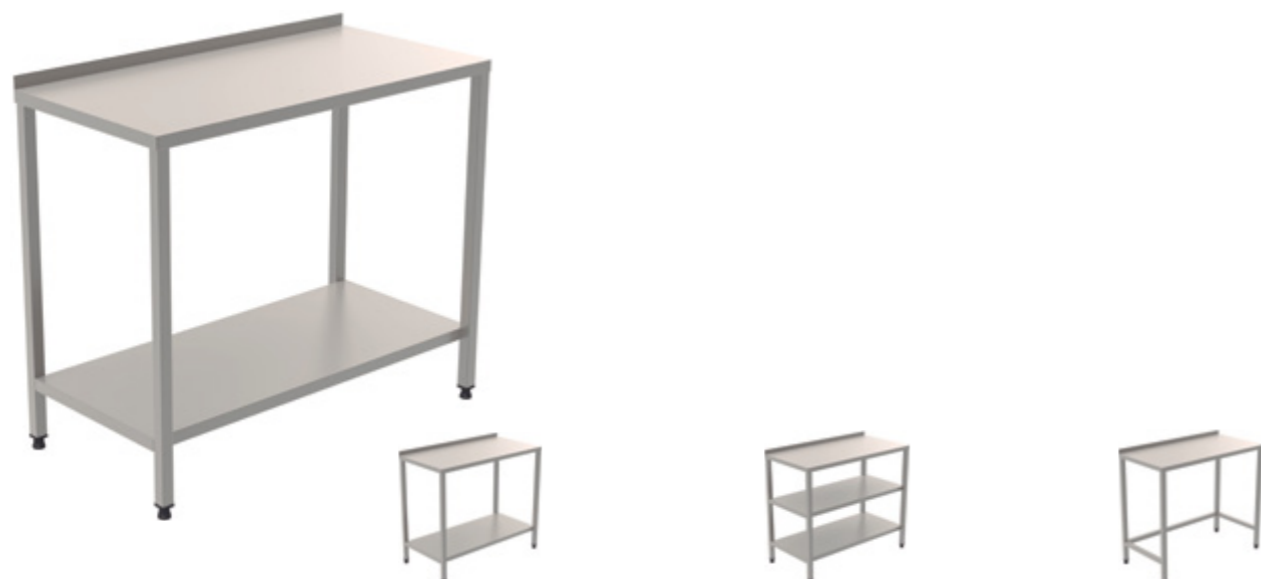

DIMENSIONES	CON ESTANTE		CON 2 ESTANTES		SIN ESTANTE	
	CÓDIGO	PRECIO	CÓDIGO	PRECIO	CÓDIGO	PRECIO
500X500X850	M055M	408 €	M055ME	448 €	M055MB	378 €
800X500X850	M085M	440 €	M085ME	493 €	M085MB	407 €
1000X500X850	M105M	454 €	M105ME	524 €	M105MB	425 €
1200X500X850	M125M	478 €	M125ME	554 €	M125MB	445 €
1300X500X850	M135M	495 €	M135ME	569 €	M135MB	455 €
1400X500X850	M145M	512 €	M145ME	583 €	M145MB	464 €
1500X500X850	M155M	536 €	M155ME	599 €	M155MB	475 €

MESAS DE TRABAJO FONDO 550

550 WORK TABLE RANGE / TABLE DE TRAVAIL GAMME 550



DIMENSIONES	CON ESTANTE		CON 2 ESTANTES		SIN ESTANTE	
	CÓDIGO	PRECIO	CÓDIGO	PRECIO	CÓDIGO	PRECIO
500X550X850	M0555M	455 €	M0555ME	546 €	M0555MB	421 €
800X550X850	M0855M	485 €	M0855ME	594 €	M0855MB	442 €
1000X550X850	M1055M	509 €	M1055ME	640 €	M1055MB	468 €
1200X550X850	M1255M	531 €	M1255ME	675 €	M1255MB	491 €
1300X550X850	M1355M	553 €	M1355ME	706 €	M1355MB	507 €
1400X550X850	M1455M	575 €	M1455ME	742 €	M1455MB	523 €
1500X550X850	M1555M	600 €	M1555ME	776 €	M1555MB	537 €

MESAS DE ALTURA 600 PARA SOPORTE DE COCCIÓN

WORK TABLE HEIGHT 600 / TABLE DE TRAVAIL HAUTEUR 600



Fondo 600	CON ESTANTE		CON ESTANTE		SIN ESTANTE		SIN ESTANTE	
	CÓDIGO	PRECIO	CÓDIGO	PRECIO	CÓDIGO	PRECIO	CÓDIGO	PRECIO
600X600X600	M066C6	451 €	M066M6	455 €	M066CB6	414 €	M066MB6	418 €
800X600X600	M086C6	478 €	M086M6	483 €	M086CB6	435 €	M086MB6	439 €
1000X600X600	M106C6	502 €	M106M6	507 €	M106CB6	461 €	M106MB6	466 €
1200X600X600	M126C6	518 €	M126M6	529 €	M126CB6	478 €	M126MB6	489 €
1400X600X600	M146C6	566 €	M146M6	574 €	M146CB6	513 €	M146MB6	521 €
1500X600X600	M156C6	586 €	M156M6	599 €	M156CB6	523 €	M156MB6	536 €
1600X600X600	M166C6	605 €	M166M6	617 €	M166CB6	549 €	M166MB6	562 €
1800X600X600	M186C6	658 €	M186M6	695 €	M186CB6	571 €	M186MB6	609 €
2000X600X600	M206C6	705 €	M206M6	738 €	M206CB6	633 €	M206MB6	667 €
2200X600X600	M226C6	843 €	M226M6	914 €	M226CB6	769 €	M226MB6	840 €
2400X600X600	M246C6	864 €	M246M6	953 €	M246CB6	782 €	M246MB6	870 €

Fondo 700	CON ESTANTE		CON ESTANTE		SIN ESTANTE		SIN ESTANTE	
	CÓDIGO	PRECIO	CÓDIGO	PRECIO	CÓDIGO	PRECIO	CÓDIGO	PRECIO
600X700X600	M067C6	479 €	M067M6	484 €	M067CB6	437 €	M067MB6	441 €
800X700X600	M087C6	501 €	M087M6	493 €	M087CB6	468 €	M087MB6	471 €
1000X700X600	M107C6	531 €	M107M6	526 €	M107CB6	491 €	M107MB6	494 €
1200X700X600	M127C6	547 €	M127M6	553 €	M127CB6	513 €	M127MB6	518 €
1400X700X600	M147C6	623 €	M147M6	601 €	M147CB6	551 €	M147MB6	563 €
1500X700X600	M157C6	638 €	M157M6	672 €	M157CB6	562 €	M157MB6	597 €
1600X700X600	M167C6	651 €	M167M6	690 €	M167CB6	590 €	M167MB6	629 €
1800X700X600	M187C6	703 €	M187M6	731 €	M187CB6	617 €	M187MB6	645 €
2000X700X600	M207C6	762 €	M207M6	787 €	M207CB6	683 €	M207MB6	708 €
2200X700X600	M227C6	889 €	M227M6	961 €	M227CB6	826 €	M227MB6	853 €
2400X700X600	M247C6	916 €	M247M6	999 €	M247CB6	844 €	M247MB6	926 €

MESAS DE RINCON

CORNER WORK TABLE / TABLE DE TRAVAIL D'ANGLE



DIMENSIONES	CON ESTANTE		CON 2 ESTANTES		SIN ESTANTE	
	CÓDIGO	PRECIO	CÓDIGO	PRECIO	CÓDIGO	PRECIO
600(A)X600(B)X850	M066R	547 €	M066RE	617 €	M066RB	526 €
700(A)X700(B)X850	M077R	608 €	M077RE	717 €	M077RB	587 €
600(A)X700(B)X850	M067R	578 €	M067RE	659 €	M067RB	553 €
700(A)X600(B)X850	M076R	578 €	M076RE	659 €	M076RB	553 €

MESAS DE TRABAJO CON CUBETA

WORK TABLE RANGE WITH BOWL / TABLE DE TRAVAIL AVEC BAC

Totalmente fabricado en acero inoxidable AISI 304, 18/10.
Se entrega totalmente montado.

Made totally of Stainless steel AISI 304, 18/10.
Delivered full assembled.

Réalisées complètement en acier inoxydable AISI 304, 18/10.
Livrés entièrement assemblés.

Encimera en 1,5 mm. reforzada con omegas.
1.5 mm thick worktop with reinforcement.
Plan de travail en 1,5 mm d'épaisseur avec renfort inférieur.

Peto posterior de 100 mm. con radio sanitario.
100 mm. rear upstand finish with radius.
Dossieret arrière de 100 mm. avec rayon sanitaire.

Cubeta soldada e insonorizada.
Welded and soundproofed bowl.
Bac soudé et insonorisées.

Frente recto de 50 mm.
50 mm straight front.
Front droit 50 mm.

Tolva de desbarace con aro de goma.
Waste hole with ring.
Trémies à déchets avec anneau.

Waste hole with ring.
Trémies à déchets avec anneau.



Patas en tubo cuadrado de 40 mm.
40 mm square tube legs.
Pieds en tube carré de 40 mm.

Estante inferior con omega de refuerzo en AISI 304.
Bottom shelf with reinforcement in AISI 304.
Étagère inférieure avec renfort en AISI 304.

Pie regulable en altura con rosca oculta.
Height adjustable foot with hidden thread.
Pied réglable en hauteur avec fil caché.

DIMENSIONES / DIMENSIONS

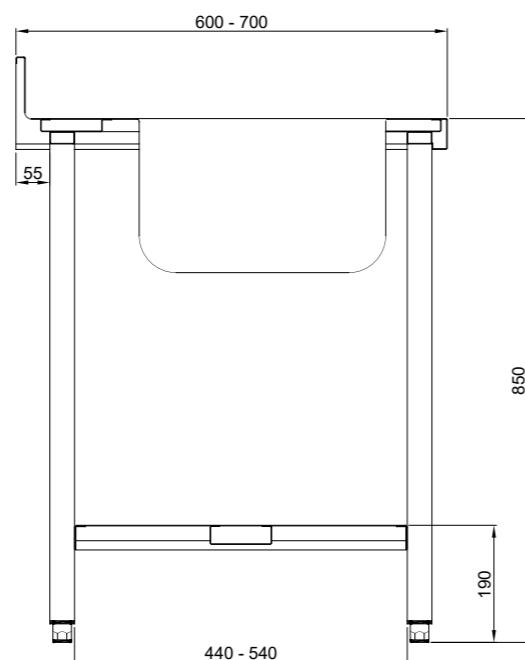

SIN ARO

Fondo 600

DIMENSIONES	CON ESTANTE		SIN ESTANTE		CON ESTANTE		SIN ESTANTE	
	CÓDIGO	PRECIO	CÓDIGO	PRECIO	CÓDIGO	PRECIO	CÓDIGO	PRECIO
1000X600X850	M106SD	714 €	M106SDB	624 €	M106SI	714 €	M106SIB	624 €
1200X600X850	M126SD	754 €	M126SDB	653 €	M126SI	754 €	M126SIB	653 €
1400X600X850	M146SD	816 €	M146SDB	716 €	M146SI	816 €	M146SIB	716 €
1600X600X850	M166SD	859 €	M166SDB	764 €	M166SI	859 €	M166SIB	764 €
1800X600X850	M186SD	918 €	M186SDB	796 €	M186SI	918 €	M186SIB	796 €
2000X600X850	M206SD	993 €	M206SDB	860 €	M206SI	993 €	M206SIB	860 €

Fondo 700

DIMENSIONES	CON ESTANTE		SIN ESTANTE		CON ESTANTE		SIN ESTANTE	
	CÓDIGO	PRECIO	CÓDIGO	PRECIO	CÓDIGO	PRECIO	CÓDIGO	PRECIO
1000X700X850	M107SD	878 €	M107SDB	764 €	M107SI	878 €	M107SIB	764 €
1200X700X850	M127SD	894 €	M127SDB	779 €	M127SI	894 €	M127SIB	779 €
1400X700X850	M147SD	937 €	M147SDB	812 €	M147SI	937 €	M147SIB	812 €
1600X700X850	M167SD	995 €	M167SDB	870 €	M167SI	995 €	M167SIB	870 €
1800X700X850	M187SD	1.104 €	M187SDB	946 €	M187SI	1.104 €	M187SIB	946 €
2000X700X850	M207SD	1.193 €	M207SDB	983 €	M207SI	1.193 €	M207SIB	983 €

CON ARO

Fondo 600

DIMENSIONES	CON ESTANTE		SIN ESTANTE		CON ESTANTE		SIN ESTANTE	
	CÓDIGO	PRECIO	CÓDIGO	PRECIO	CÓDIGO	PRECIO	CÓDIGO	PRECIO
1200X600X850	M126SDA	844 €	M126SDBA	762 €	M126SIA	844 €	M126SIBA	762 €
1400X600X850	M146SDA	874 €	M146SDBA	792 €	M146SIA	874 €	M146SIBA	792 €
1600X600X850	M166SDA	905 €	M166SDBA	813 €	M166SIA	905 €	M166SIBA	813 €
1800X600X850	M186SDA	968 €	M186SDBA	869 €	M186SIA	968 €	M186SIBA	869 €
2000X600X850	M206SDA	1.000 €	M206SDBA	891 €	M206SIA	1.000 €	M206SIBA	891 €

Fondo 700

DIMENSIONES	CON ESTANTE		SIN ESTANTE		CON ESTANTE		SIN ESTANTE	
	CÓDIGO	PRECIO	CÓDIGO	PRECIO	CÓDIGO	PRECIO	CÓDIGO	PRECIO
1200X700X850	M127SDA	866 €	M127SDBA	780 €	M127SIA	866 €	M127SIBA	780 €
1400X700X850	M147SDA	901 €	M147SDBA	812 €	M147SIA	901 €	M147SIBA	812 €
1600X700X850	M167SDA	935 €	M167SDBA	836 €	M167SIA	935 €	M167SIBA	836 €
1800X700X850	M187SDA	1.002 €	M187SDBA	893 €	M187SIA	1.002 €	M187SIBA	893 €
2000X700X850	M207SDA	1.037 €	M207SDBA	917 €	M207SIA	1.037 €	M207SIBA	917 €

MESAS SOPORTE PARA HORNOS

SUPPORT FOR OVEN / SOUTIEN POUR FOUR



Totalmente fabricado en acero inoxidable AISI 304, 18/10. Frente recto de 50 mm. Guías soldadas. Patas en tubo cuadrado de 40 mm. Pie regulable en altura con rosca oculta. Se entrega totalmente montado.

Made totally of Stainless steel AISI 304, 18/10. 50 mm straight front. 40 mm square tube legs. Height adjustable foot with hidden thread. Welded guides. Delivered full assembled.

Réalisées complètement en acier inoxydable AISI 304, 18/10. Front droit 50 mm. Guides soudés. Pieds en tube carré de 40 mm. Pied réglable en hauteur avec fil caché. Livrés entièrement assemblés.



GASTRONORM 1/1



GASTRONORM 2/1



PASTELERIA

DIMENSIONES	CÓDIGO	BANDEJA	PRECIO	CÓDIGO	BANDEJA	PRECIO	CÓDIGO	BANDEJA	PRECIO
850X750X700	SH141175	14 ud.-GN 1/1	745 €	SH072175	7 ud.-GN 2/1	649 €	SH066475	6 ud.-600X400	646 €
850X850X700	SH141185	14 ud.-GN 1/1	780 €	SH072185	7 ud.-GN 2/1	718 €	SH066485	6 ud.-600X400	737 €
1200X850X700	SH211185	21 ud.-GN 1/1	911 €	SH142185	14 ud.-GN 2/1	885 €	SH126485	12 ud.-600X400	908 €
1200X950X700	SH211195	21 ud.-GN 1/1	962 €	SH142195	14 ud.-GN 2/1	958 €	SH126495	12 ud.-600X400	999 €

ESTANTE INFERIOR

LOWER SHELF / ETAGÈRE



Totalmente fabricado en acero inoxidable AISI 304, 18/10. Con omega de refuerzo. Se entrega totalmente montado.

Made totally of Stainless steel AISI 304, 18/10 with reinforcement. Delivered full assembled.

Réalisées complètement en acier inoxydable AISI 304, 18/10. Avec renfort. Livrés entièrement assemblés.

FONDO 550			FONDO 600			FONDO 700		
DIMENSIONES	CÓDIGO	PRECIO	DIMENSIONES	CÓDIGO	PRECIO	DIMENSIONES	CÓDIGO	PRECIO
500X550	ENT055	91 €	600X600	ENT066	97 €	600X700	ENT067	107 €
800X550	ENT085	117 €	800X600	ENT086	122 €	800X700	ENT087	137 €
1000X550	ENT105	130 €	1000X600	ENT106	137 €	1000X700	ENT107	149 €
1200X550	ENT125	139 €	1200X600	ENT126	146 €	1200X700	ENT127	172 €
1300X550	ENT135	150 €	1400X600	ENT146	166 €	1400X700	ENT147	190 €
1400X550	ENT145	158 €	1500X600	ENT156	170 €	1500X700	ENT157	195 €
1500X550	ENT155	164 €	1600X600	ENT166	175 €	1600X700	ENT167	200 €
-	-	-	1800X600	ENT186	241 €	1800X700	ENT187	236 €
-	-	-	2000X600	ENT206	253 €	2000X700	ENT207	266 €
-	-	-	2200X600	ENT226	263 €	2200X700	ENT227	278 €
-	-	-	2400X600	ENT246	276 €	2400X700	ENT247	320 €

Dimensiones en mm. Los precios indicados serán gravados con el I.V.A. correspondiente.

ACCESORIOS PARA MESAS

TABLE ACCESSORIES / ACCESSOIRES DE TABLE

CAJÓN SIMPLE / SINGLE DRAWER / TIROIR SIMPLE

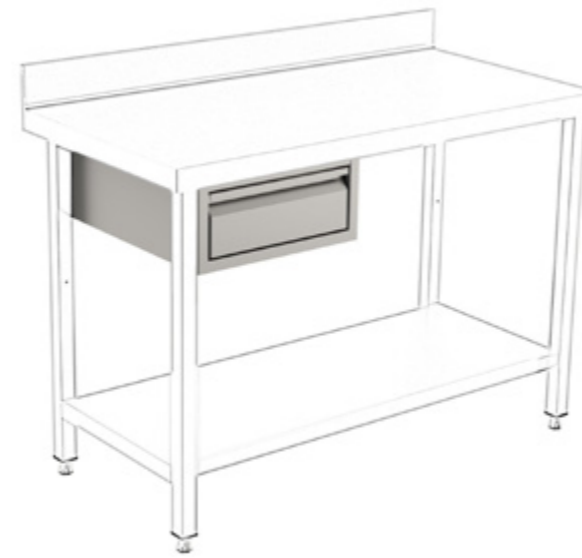

Totalmente fabricado en acero inoxidable AISI 304. Extracción 100% del cajón. Compatible con GN 1/1.

Made totally of Stainless steel AISI 304. 100% extraction of the drawer. Compatible with GN 1/1.

Réalisées complètement en acier inoxydable AISI 304. 100% d'extraction du tiroir. Compatible avec GN 1/1.



DIMENSIONES	CÓDIGO	PRECIO
400X560X150	CAJO1	194 €

CAJONERA / DRAWER UNIT / BLOC-TIROIRS



Totalmente fabricado en acero inoxidable AISI 304. Extracción 100% del cajón. Compatible con GN 1/1.

Made totally of Stainless steel AISI 304. 100% extraction of the drawer. Compatible with GN 1/1.

Réalisées complètement en acier inoxydable AISI 304. 100% d'extraction du tiroir. Compatible avec GN 1/1.



DIMENSIONES	CÓDIGO	PRECIO	CÓDIGO	PRECIO
400X560X605	CAJO3	600 €	CAJO4	706 €

SOPORTE PARA BANDEJAS

TRAY SUPPORT / SUPPORT POUR BACS



Totalmente fabricado en acero inoxidable AISI 304, 18/10.

Made totally of Stainless steel AISI 304, 18/10.

Réalisées complètement en acier inoxydable AISI 304, 18/10.

DIMENSIONES	CAPACIDAD	CÓDIGO	PRECIO
400X560X605	5 (GN 1/1)	BAS511	346 €
725X560X605	5 (GN 2/1)	BAS521	435 €
660X560X605	5 (600X400)	BAS564	382 €

ACCESORIOS PARA MESAS

TABLE ACCESSORIES / ACCESSOIRES DE TABLE

PETO LATERAL / SIDE TOP PANEL/ DOSSERET LATÉRAL

Totalmente fabricado en acero inoxidable AISI 304.
Fijación mediante tornillos.

Made totally of Stainless steel AISI 304.
Fixing with screws.

Réalisées complètement en acier inoxydable AISI 304.
Fixation par vis.

FONDO MESA	LADO MESA	CÓDIGO	PRECIO
600	DERECHO	ALZD06	121 €
700		ALZD07	131 €
600	IZQUIERDO	ALZI06	121 €
700		ALZI07	131 €



PANEL LATERAL / SIDE TABLE PANEL/ PANNEAU LATÉRAL

Totalmente fabricado en acero inoxidable AISI 304.
Fijación mediante tornillos.

Made totally of Stainless steel AISI 304.
Fixing with screws.

Réalisées complètement en acier inoxydable AISI 304.
Fixation par vis.

FONDO MESA	CÓDIGO	PRECIO
600	PLMF06	117 €
700	PLMF07	124 €



PUERTA PARA ARO DE DESBARACE

DOOR WASTE ZONE / PORTE POUR ZONE DE DÉCHETS

Totalmente fabricado en acero inoxidable AISI 304.
Bisagras abatibles.
Cierre magnético.

Completely made of AISI 304 stainless steel.
Folding hinges.
Magnetic closure.

Entièrement en acier inoxydable AISI 304.
Charnières rabattables.
Fermeture magnétique.

CÓDIGO	PRECIO
PTAD	225 €



ACCESORIOS PARA MESAS

TABLE ACCESSORIES / ACCESSOIRES DE TABLE

SOPORTES PARA ENCIMERAS

SUPPORTS FOR WORKTOP SUPPORTS POUR PLAN DE TRAVAIL

Totalmente fabricado en acero inoxidable AISI 304, 18/10.

Made totally of Stainless steel AISI 304, 18/10.

Réalisées complètement en acier inoxydable AISI 304, 18/10.



FONDO	CÓDIGO	PRECIO	CÓDIGO	PRECIO
600	SPMF06	152 €	SPMF06P	161 €
700	SPMF07	156 €	SPMF07P	168 €

KIT DE RUEDAS PARA MESAS CON PATAS

WHEEL KIT FOR TABLES WITH LEGS KIT DE ROUES POUR TABLES AVEC PIEDS



LONGITUD MESA	CÓDIGO	PRECIO
≤ 2000	RDE04	244 €
> 2000	RDE06	338 €

KIT DE RUEDAS PARA MESAS CON ARMARIO

WHEEL KIT FOR TABLES WITH CLOSET KIT DE ROUES POUR TABLES AVEC ARMOIRE



LONGITUD MESA	CÓDIGO	PRECIO
≤ 2000	RDP04	282 €
> 2000	RDP06	375 €

MESA CON ARMARIO NEUTRO

TABLE WITH NEUTRAL CABINET / TABLE AVEC ARMOIRE NEUTRE

Totalmente fabricado en acero inoxidable AISI 304, 18/10. Se entrega totalmente montado.

Made totally of Stainless steel AISI 304, 18/10. Delivered full assembled.

Réalisées complètement en acier inoxydable AISI 304, 18/10. Livrés entièrement assemblés.

Encimera en 1,5 mm. reforzada con omegas. 1.5 mm thick worktop with reinforcement. Plan de travail en 1,5 mm d'épaisseur avec renfort inférieur.



Peto posterior de 100 mm. con radio sanitario. 100 mm. rear upstand finish with radius. Dossieret arrière de 100 mm. avec rayon sanitaire.

Frente recto de 50 mm. 50 mm straight front. Front droit 50 mm.

Estante interior con omega de refuerzo en AISI 304. Inner shelf with reinforcement in AISI 304. Étagère intérieure avec renfort en AISI 304.

Pie regulable en altura con rosca oculta. Height adjustable foot with hidden thread. Pied réglable en hauteur avec fil caché.

DIMENSIONES / DIMENSIONS

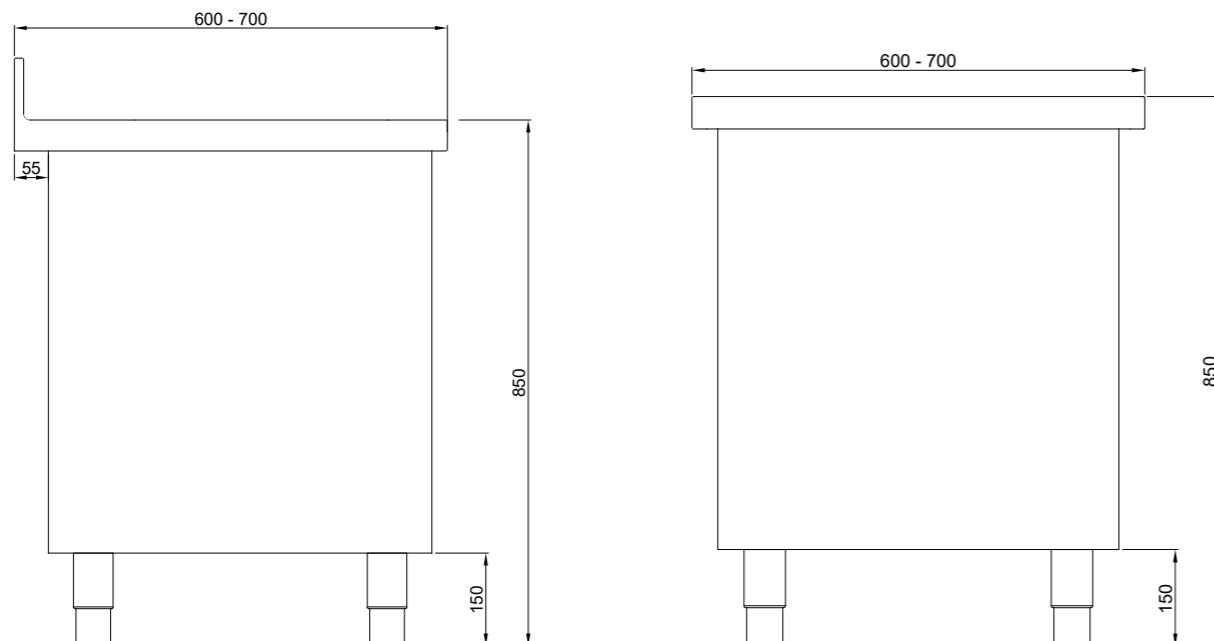

CENTRAL

Fondo 600

DIMENSIONES	PUERTAS ABATIBLES		SIN PUERTAS		PUERTAS CORREDERAS		DOBLE APERTURA	
	CÓDIGO	PRECIO	CÓDIGO	PRECIO	CÓDIGO	PRECIO	CÓDIGO	PRECIO
1000X600X850	MN106CPB	1.250 €	MN106CSP	879 €	MN106CPC	1.150 €	MN106CPC2	1.376 €
1200X600X850	MN126CPB	1.342 €	MN126CSP	943 €	MN126CPC	1.196 €	MN126CPC2	1.476 €
1400X600X850	MN146CPB	1.545 €	MN146CSP	1.004 €	MN146CPC	1.276 €	MN146CPC2	1.574 €
1600X600X850	MN166CPB	1.644 €	MN166CSP	1.070 €	MN166CPC	1.394 €	MN166CPC2	1.676 €
1800X600X850	MN186CPB	1.744 €	MN186CSP	1.137 €	MN186CPC	1.482 €	MN186CPC2	1.866 €
2000X600X850	MN206CPB	1.855 €	MN206CSP	1.228 €	MN206CPC	1.578 €	MN206CPC2	1.920 €

Fondo 700

DIMENSIONES	PUERTAS ABATIBLES		SIN PUERTAS		PUERTAS CORREDERAS		DOBLE APERTURA	
	CÓDIGO	PRECIO	CÓDIGO	PRECIO	CÓDIGO	PRECIO	CÓDIGO	PRECIO
1000X700X850	MN107CPB	1.282 €	MN107CSP	906 €	MN107CPC	1.180 €	MN107CPC2	1.429 €
1200X700X850	MN127CPB	1.365 €	MN127CSP	971 €	MN127CPC	1.302 €	MN127CPC2	1.529 €
1400X700X850	MN147CPB	1.959 €	MN147CSP	1.036 €	MN147CPC	1.361 €	MN147CPC2	1.725 €
1600X700X850	MN167CPB	2.216 €	MN167CSP	1.102 €	MN167CPC	1.456 €	MN167CPC2	1.784 €
1800X700X850	MN187CPB	2.308 €	MN187CSP	1.173 €	MN187CPC	1.545 €	MN187CPC2	1.944 €
2000X700X850	MN207CPB	2.402 €	MN207CSP	1.268 €	MN207CPC	1.632 €	MN207CPC2	2.069 €

MURAL

Fondo 600

DIMENSIONES	PUERTAS ABATIBLES		SIN PUERTAS		PUERTAS CORREDERAS	
	CÓDIGO	PRECIO	CÓDIGO	PRECIO	CÓDIGO	PRECIO
1000X600X850	MN106MPB	1.280 €	MN106MSP	909 €	MN106MPC	1.167 €
1200X600X850	MN126MPB	1.371 €	MN126MSP	972 €	MN126MPC	1.237 €
1400X600X850	MN146MPB	1.919 €	MN146MSP	1.035 €	MN146MPC	1.319 €
1600X600X850	MN166MPB	2.177 €	MN166MSP	1.101 €	MN166MPC	1.438 €
1800X600X850	MN186MPB	2.275 €	MN186MSP	1.166 €	MN186MPC	1.523 €
2000X600X850	MN206MPB	2.372 €	MN206MSP	1.252 €	MN206MPC	1.617 €

Fondo 700

DIMENSIONES	PUERTAS ABATIBLES		SIN PUERTAS		PUERTAS CORREDERAS	
	CÓDIGO	PRECIO	CÓDIGO	PRECIO	CÓDIGO	PRECIO
1000X700X850	MN107MPB	1.314 €	MN107MSP	939 €	MN107MPC	1.211 €
1200X700X850	MN127MPB	1.397 €	MN127MSP	1.003 €	MN127MPC	1.334 €
1400X700X850	MN147MPB	1.993 €	MN147MSP	1.071 €	MN147MPC	1.393 €
1600X700X850	MN167MPB	2.253 €	MN167MSP	1.139 €	MN167MPC	1.493 €
1800X700X850	MN187MPB	2.343 €	MN187MSP	1.207 €	MN187MPC	1.580 €
2000X700X850	MN207MPB	2.430 €	MN207MSP	1.296 €	MN207MPC	1.661 €

MESAS CON ARMARIO NEUTRO Y CAJONES

TABLES WITH NEUTRAL CABINET AND DRAWERS /
TABLES AVEC ARMOIRE NEUTRE ET TIROIRS

Totalmente fabricado en acero inoxidable AISI 304, 18/10.
Se entrega totalmente montado.

Made totally of Stainless steel AISI 304, 18/10
Delivered full assembled.

Réalisées complètement en acier inoxydable AISI 304, 18/10.
Livrés entièrement assemblés.

Encimera en 1,5 mm. reforzada con omegas.
1.5 mm thick worktop with reinforcement.
Plan de travail en 1,5 mm d'épaisseur avec renfort inférieur.

Peto posterior de 100 mm. con radio sanitario.
100 mm. rear upstand finish with radius.
Dossieret arrière de 100 mm. avec rayon sanitaire.

Frente recto de 50 mm.
50 mm straight front.
Front droit 50 mm.

Cajón extraíble. Compatible con GN 1/1

Removable drawer.
Compatible with GN 1/1
Tiroir amovible.
Compatible avec GN 1/1

Pie regulable en altura con rosca oculta.
Height adjustable foot with hidden thread.
Pied réglable en hauteur avec fil caché.

Estante interior regulable con omega de refuerzo en AISI 304.
Inner adjustable shelf with reinforcement in AISI 304.
Étagère intérieure réglable avec renfort en AISI 304.



Fondo 600

CENTRAL

CENTRAL

MURAL

MURAL

DIMENSIONES	CÓDIGO	PRECIO	CÓDIGO	PRECIO	CÓDIGO	PRECIO	CÓDIGO	PRECIO
1400X600X850	MN146CCAJI	2.006 €	MN146CCAJD	2.006 €	MN146MCAJI	2.036 €	MN146MCAJD	2.036 €
1600X600X850	MN166CCAJI	2.090 €	MN166CCAJD	2.090 €	MN166MCAJI	2.121 €	MN166MCAJD	2.121 €
1800X600X850	MN166CCAJI	2.179 €	MN166CCAJD	2.179 €	MN166MCAJI	2.209 €	MN166MCAJD	2.209 €
2000X600X850	MN206CCAJI	2.306 €	MN206CCAJD	2.306 €	MN206MCAJI	2.328 €	MN206MCAJD	2.328 €
2200X600X850	MN226CCAJI	2.393 €	MN226CCAJD	2.393 €	MN226MCAJI	2.427 €	MN226MCAJD	2.427 €
2400X600X850	MN246CCAJI	2.492 €	MN246CCAJD	2.492 €	MN246MCAJI	2.531 €	MN246MCAJD	2.531 €



Fondo 700

CENTRAL

CENTRAL

MURAL

MURAL

DIMENSIONES	CÓDIGO	PRECIO	CÓDIGO	PRECIO	CÓDIGO	PRECIO	CÓDIGO	PRECIO
1400X700X850	MN147CCAJI	2.085 €	MN147CCAJD	2.085 €	MN147MCAJI	2.119 €	MN147MCAJD	2.119 €
1600X700X850	MN167CCAJI	2.211 €	MN167CCAJD	2.211 €	MN167MCAJI	2.245 €	MN167MCAJD	2.245 €
1800X700X850	MN167CCAJI	2.275 €	MN167CCAJD	2.275 €	MN167MCAJI	2.309 €	MN167MCAJD	2.309 €
2000X700X850	MN207CCAJI	2.379 €	MN207CCAJD	2.379 €	MN207MCAJI	2.408 €	MN207MCAJD	2.408 €
2200X700X850	MN227CCAJI	2.473 €	MN227CCAJD	2.473 €	MN227MCAJI	2.505 €	MN227MCAJD	2.505 €
2400X700X850	MN247CCAJI	2.562 €	MN247CCAJD	2.562 €	MN247MCAJI	2.596 €	MN247MCAJD	2.596 €

MESAS CALIENTES

HOT TABLES / TABLES CHAUDES

Totalmente fabricado en acero inoxidable AISI 304, 18/10.
Calentamiento mediante termo ventilador de 2 kW.
Se entrega totalmente montado.

Made totally of Stainless steel AISI 304, 18/10.
Heating by 2 kW thermo fan.
Delivered full assembled.

Réalisées complètement en acier inoxydable AISI 304, 18/10.
Chauffage par thermo-ventilateur 2 kW.
Livrés entièrement assemblés.

Encimera en 1,5 mm. reforzada con omegas.
1.5 mm thick worktop with reinforcement.
Plan de travail en 1,5 mm d'épaisseur avec renfort inférieur.

Peto posterior de 100 mm. con radio sanitario.
100 mm. rear upstand finish with radius.
Dossieret arrière de 100 mm. avec rayon sanitaire.

Frente recto de 50 mm.
50 mm straight front.
Front droit 50 mm.

Termostato digital con indicador de temperatura.

Digital thermostat with temperature indicator.
Thermostat numérique avec indicateur de température.

Pie regulable en altura con rosca oculta.
Height adjustable foot with hidden thread.
Pied réglable en hauteur avec fil caché.

Estante interior fijo con omega de refuerzo en AISI 304.
Fixed Inner shelf with reinforcement in AISI 304.
Étagère intérieure fixe avec renfort en AISI 304.



Fondo 600

CENTRAL

DOBLE

MURAL

DIMENSIONES	CÓDIGO	PRECIO	CÓDIGO	PRECIO	CÓDIGO	PRECIO
1000X600X850	MC106CPC	1.868 €	MC106CPC2	2.084 €	MC106MPC	1.961 €
1200X600X850	MC126CPC	1.955 €	MC126CPC2	2.193 €	MC126MPC	1.984 €
1400X600X850	MC146CPC	2.171 €	MC146CPC2	2.340 €	MC146MPC	2.199 €
1600X600X850	MC166CPC	2.387 €	MC166CPC2	2.648 €	MC166MPC	2.414 €
1800X600X850	MC186CPC	2.617 €	MC186CPC2	3.024 €	MC186MPC	2.635 €
2000X600X850	MC206CPC	3.035 €	MC206CPC2	3.600 €	MC206MPC	3.068 €



Fondo 700

CENTRAL

DOBLE

MURAL

DIMENSIONES	CÓDIGO	PRECIO	CÓDIGO	PRECIO	CÓDIGO	PRECIO
1000X700X850	MC107CPC	1.947 €	MC107CPC2	2.123 €	MC107MPC	1.995 €
1200X700X850	MC127CPC	2.027 €	MC127CPC2	2.251 €	MC127MPC	2.047 €
1400X700X850	MC147CPC	2.271 €	MC147CPC2	2.392 €	MC147MPC	2.251 €
1600X700X850	MC167CPC	2.500 €	MC167CPC2	2.818 €	MC167MPC	2.516 €
1800X700X850	MC187CPC	2.749 €	MC187CPC2	3.112 €	MC187MPC	2.739 €
2000X700X850	MC207CPC	3.109 €	MC207CPC2	3.663 €	MC207MPC	3.089 €

ESTANTES DE SOBREMESA

TABLES OVER SHELF / ETAGERE SUR TABLE

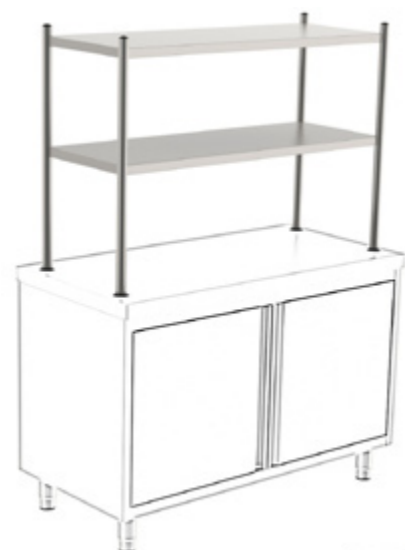

Totalmente fabricado en acero inoxidable AISI 304, 18/10. Estantes con refuerzo inferior. Patas en tubo redondo. Se entrega totalmente montado.

Made totally of Stainless steel AISI 304, 18/10. Shelves with bottom reinforcement. Round tube legs. Delivered full assembled.

Réalisées complètement en acier inoxydable AISI 304, 18/10. Étagères avec renfort inférieur. Pieds en tube rond. Livrés entièrement assemblés.



SIMPLE



DOBLE

DIMENSIONES	CÓDIGO	PRECIO
1000X400X350	ESP104S	348 €
1200X400X350	ESP124S	353 €
1400X400X350	ESP144S	362 €
1600X400X350	ESP164S	378 €
1800X400X350	ESP184S	395 €
2000X400X350	ESP204S	416 €

DIMENSIONES	CÓDIGO	PRECIO
1000X400X350/750	ESP104D	480 €
1200X400X350/750	ESP124D	490 €
1400X400X350/750	ESP144D	501 €
1600X400X350/750	ESP164D	528 €
1800X400X350/750	ESP184D	574 €
2000X400X350/750	ESP204D	610 €

ESTANTES SUSPENDIDOS

HANGING SHELVES / ÉTAGÈRES SUSPENDUES



Totalmente fabricado en acero inoxidable AISI 304, 18/10. Estantes con refuerzo inferior. Patas en tubo redondo. Se entrega totalmente montado.

Made totally of Stainless steel AISI 304, 18/10. Shelves with bottom reinforcement. Round tube legs. Delivered full assembled.

Réalisées complètement en acier inoxydable AISI 304, 18/10. Étagères avec renfort inférieur. Pieds en tube rond. Livrés entièrement assemblés.



SIMPLE



DOBLE

DIMENSIONES	CÓDIGO	PRECIO
1000X400X350	ESP104ST	418 €
1200X400X350	ESP124ST	423 €
1400X400X350	ESP144ST	435 €
1600X400X350	ESP164ST	454 €
1800X400X350	ESP184ST	475 €
2000X400X350	ESP204ST	499 €

DIMENSIONES	CÓDIGO	PRECIO
1000X400X350/750	ESP104DT	577 €
1200X400X350/750	ESP124DT	588 €
1400X400X350/750	ESP144DT	601 €
1600X400X350/750	ESP164DT	633 €
1800X400X350/750	ESP184DT	688 €
2000X400X350/750	ESP204DT	732 €

ELEMENTO CALEFACTOR PARA ESTANTES DE SOBREMESA

HEATING ELEMENT FOR SHELF / ELEMENT DE CHAUFAGE POR ETAGERE



Totalmente fabricado en acero inoxidable AISI 304, 18/10. Calentamiento mediante lámparas halógenas. Interruptor luminoso de encendido. Preparado para ser anclado en el refuerzo del estante.

Completely made of AISI 304, 18/10 stainless steel. Heating by halogen lamps. Illuminated power switch. Prepared to be anchored in the reinforcement of the shelf.

Entièrement en acier inoxydable AISI 304, 18/10. Chauffage par lampes halogènes. Interrupteur d'alimentation lumineuse. Préparé pour être ancré dans le renfort de l'étagère.

LONGITUD ESTANTE	POTENCIA	CÓDIGO	PRECIO
1000	600 w	CAL100	518 €
1200	900 w	CAL120	566 €
1400	900 w	CAL140	600 €
1600	1200 w	CAL160	624 €
1800	1200 w	CAL180	662 €
2000	1500 Kw	CAL200	701 €

ARMARIO CALIENTA PLATOS

HEATER CABINET / CABINET DE CHAUFAGE



Totalmente fabricado en acero inoxidable AISI 304, 18/10. Calentamiento mediante resistencia acorazada. Encimera en 1,5 mm. reforzada con omegas. Frente recto de 50 mm. Termostato digital con indicador de temperatura. Pie regulable en altura con rosca oculta. Se entrega totalmente montado.

Made totally of Stainless steel AISI 304, 18/10. Heating by resistance. 1.5 mm thick worktop with reinforcement. 50 mm straight front. Digital thermostat with temperature indicator. Height adjustable foot with hidden thread. Delivered full assembled.

Réalisées complètement en acier inoxydable AISI 304, 18/10. Chauffage par résistance blindée. Plan de travail en 1,5 mm d'épaisseur avec renfort inférieur. Front droit 50 mm. Thermostat numérique avec indicateur de température. Pied réglable en hauteur avec fil caché. Livrés entièrement assemblés.

DIMENSIONES	CENTRAL		MURAL	
	CÓDIGO	PRECIO	CÓDIGO	PRECIO
400X500X850	CAP40C	898 €	CAP40M	906 €
800X500X850	CAP80C	1.363 €	CAP80M	1.375 €

MUEBLE CAFETERO

CUPBOARD FOR COFFEE MACHINE / CABINET POUR MACHINE A CAFE

Totalmente fabricado en acero inoxidable AISI 304, 18/10. Se entrega totalmente montado.

Made totally of Stainless steel AISI 304, 18/10. Delivered full assembled.

Réalisées complètement en acier inoxydable AISI 304, 18/10. Livrés entièrement assemblés.

Taladro para conexiones.

Drill for connections.
Perceuse pour les connexions.

Encimera en 1,5 mm. reforzada con omegas.

1.5 mm thick worktop with reinforcement.
Plan de travail en 1,5 mm d'épaisseur avec renfort inférieur.

Cajón para posos con picamarros.

Grounds drawer with hitting bar.
Tiroir à marc avec barre de frappe.

Peto posterior de 50 mm. con radio sanitario.

50 mm. rear upstand finish with radius.
Dossier arrière de 50 mm. avec rayon sanitaire.

Frente recto de 50 mm.

50 mm straight front.
Front droit 50 mm.

Cajón extraíble.

Removable drawer.
Tiroir amovible.

Pie regulable en altura con rosca oculta.

Height adjustable foot with hidden thread.
Pied réglable en hauteur avec fil caché.

Armario inferior con puerta abatible.

Lower cabinet with hinged door.
Meuble bas avec porte battante.

Estante interior regulable con omega de refuerzo en AISI 304.

Inner adjustable shelf with reinforcement in AISI 304.
Étagère intérieure réglable avec renfort en AISI 304.



MUEBLE CAFETERO

CUPBOARD FOR COFFEE MACHINE / CABINET POUR MACHINE A CAFE

CON TOLVA, PUERTAS Y CAJONES

WITH HOPPER, DOORS AND DRAWERS AVEC TRÉMIE, PORTES ET TIROIRS



DIMENSIONES	500X600X1050	1000X600X1050	1500X600X1050
CÓDIGO	M056MC	M106MC	M156MC
PRECIO	770 €	1.038 €	1.456 €

CON TOLVA, PUERTAS Y ESTANTES

WITH HOPPER, DOORS AND SHELVES AVEC TRÉMIE, PORTES ET ÉTAGÈRES



DIMENSIONES	1000X600X1050	1000X600X1050	1500X600X1050
CÓDIGO	M106MCD	M106MCI	M156MCC
PRECIO	958 €	958 €	1.260 €

ABIERTO CON ESTANTES REGULABLES

OPEN WITH ADJUSTABLE SHELVES OUVERT AVEC ÉTAGÈRES RÉGLABLES



Fondo 350

DIMENSIONES	CÓDIGO	PRECIO	CÓDIGO	PRECIO
500X350X1050	M053MA2	393 €	M053MA3	432 €
1000X350X1050	M103MA2	573 €	M103MA3	619 €
1500X350X1050	M153MA2	793 €	M153MA3	859 €
2000X350X1050	M203MA2	950 €	M203MA3	1.015 €
2500X350X1050	M253MA2	1.361 €	M253MA3	1.417 €

Fondo 600

DIMENSIONES	CÓDIGO	PRECIO	CÓDIGO	PRECIO
500X600X1050	M056MA2	647 €	M056MA3	686 €
1000X600X1050	M106MA2	769 €	M106MA3	830 €
1500X600X1050	M156MA2	951 €	M156MA3	1.031 €
2000X600X1050	M206MA2	1.238 €	M206MA3	1.336 €
2500X600X1050	M256MA2	1.645 €	M256MA3	1.695 €

ARMARIOS DE PARED

WALL CABINET / ARMOIRE MURALE

Totalmente fabricado en acero inoxidable AISI 304, 18/10. Panel de base y estante intermedio reforzado con omegas. Estante intermedio regulable en altura con tres posiciones de regulación. Incluido kit de anclaje a pared. **Se entrega totalmente montado.**

Made totally of Stainless steel AISI 304, 18/10. Base panel and intermediate shelf reinforced with omegas. Height-adjustable intermediate shelf with three adjustment positions. Wall anchor kit included. It is delivered fully assembled.

Réalisées complètement en acier inoxydable AISI 304, 18/10. Panneau de base et étagère intermédiaire renforcés d'omégas. Tablette intermédiaire réglable en hauteur avec trois positions de réglage. Kit d'ancrage mural inclus. Il est livré entièrement monté.

ARMARIO ABIERTO

OPEN WALL CABINET ARMOIRE MURALE OUVERT



DIMENSIONES	CÓDIGO	PRECIO
1000X400X600	AM104SP	580 €
1200X400X600	AM124SP	649 €
1400X400X600	AM144SP	714 €
1600X400X600	AM164SP	772 €
1800X400X600	AM184SP	820 €

ARMARIO CON PUERTAS CORREDERAS

WALL CABINET WITH FOLDING DOORS ARMOIRE AVEC PORTES COULISSANTES



DIMENSIONES	CÓDIGO	PRECIO
1000X400X600	AM104PC	735 €
1200X400X600	AM124PC	818 €
1400X400X600	AM144PC	954 €
1600X400X600	AM164PC	970 €
1800X400X600	AM184PC	1.030 €

ARMARIO CON PUERTAS ABATIBLES

OPEN WALL CABINET ARMOIRE MURALE OUVERT



DIMENSIONES	CÓDIGO	PRECIO
600X400X600	AM064PB	614 €
800X400X600	AM084PB	778 €
1000X400X600	AM104PB	829 €
1200X400X600	AM124PB	910 €

ARMARIO CON ESCURREPLATOS

WALL CABINET WITH FOLDING DOORS ARMOIRE AVEC PORTES COULISSANTES



DIMENSIONES	CÓDIGO	PRECIO
1000X400X600	AM104PCE	841 €
1200X400X600	AM124PCE	881 €
1400X400X600	AM144PCE	937 €
1600X400X600	AM164PCE	1.002 €
1800X400X600	AM184PCE	1.076 €

ARMARIOS PARA VAJILLA

CABINETS FOR DISHES / ARMOIRES POUR LA VAISSELLE



Totalmente fabricado en acero inoxidable AISI 304, 18/10. Panel de base y estante intermedio reforzado con omegas. Estantes intermedios regulables en altura. **Se entrega totalmente montado.**

Made totally of Stainless steel AISI 304, 18/10. Base panel and intermediate shelf reinforced with omegas. Height-adjustable intermediate shelf. It is delivered fully assembled.

Réalisées complètement en acier inoxydable AISI 304, 18/10. Panneau de base et étagère intermédiaire renforcés d'omégas. Tablette intermédiaire réglable en hauteur. Il est livré entièrement monté.



DIMENSIONES	PUERTA ABATIBLE		PUERTAS ABATIBLES		PUERTAS CORREDERAS	
	CÓDIGO	PRECIO	CÓDIGO	PRECIO	CÓDIGO	PRECIO
600X600X1900	AP066PB	1.166 €	-	-	-	-
1000X600X1900	-	-	AP106PB	1.641 €	AP106PC	1.704 €
1200X600X1900	-	-	AP126PB	1.903 €	AP126PC	2.081 €
1400X600X1900	-	-	AP146PB	2.015 €	AP146PC	2.250 €

ARMARIOS PARA PRODUCTOS DE LIMPIEZA

CABINETS FOR CLEANING PRODUCTS / ARMOIRES POUR PRODUITS DE NETTOYAGE



Totalmente fabricado en acero inoxidable AISI 304, 18/10. Se entrega totalmente montado.

Made totally of Stainless steel AISI 304, 18/10. Delivered full assembled.

Réalisées complètement en acier inoxydable AISI 304, 18/10. Livrés entièrement assemblés.



DIMENSIONES	CÓDIGO	PRECIO	CÓDIGO	PRECIO
600X450X1900	AP064PL	1.168 €	-	-
1000X450X1900	-	-	AP104PL	1.487 €
1200X450X1900	-	-	AP124PL	1.924 €



Estantes y estanterías.

Shelves. / Étagères.

	pág.
ESTANTERÍAS DE ALUMINIO Y POLIETILENO / ALUMINUM AND POLYETHYLENE SHELVES / ÉTAGÈRES EN ALUMINIUM ET POLYÉTHYLÈNE	70
ESTANTES DE PARED LISO / FIXED WALL SELF / ÉTAGÈRE MURALE FIXE	76
ESTANTES DE PARED TUBULAR / TUBULAR WALL SELF / ÉTAGÈRE MURALE TUBULAIRE	76
ESTANTES DE PARED PARA CESTAS / WALL SELF FOR BASKETS / ÉTAGÈRE MURALE POUR PANIERS	76
ESTANTES MURALES PARA CAMPANAS / WALL SHELVES FOR HOODS / ÉTAGÈRES MURALES POUR HOTTES	77
ESTANTES MURALES PARA PLATO / WALL SHELVES FOR PLATES / ÉTAGÈRES MURALES POUR ASSIETTES	77
ESTANTES MURALES PARA MICROONDAS / WALL SHELVES FOR MICROWAVES / ÉTAGÈRES MURALES POUR MICRO-ONDES	77
ESTANTES MURALES PARA CUBETAS GASTRONORM / WALL SHELVES FOR GASTRONORM BUCKETS / ÉTAGÈRES MURALES POUR BACS GASTRONORM	77



ESTANTERÍAS RECTAS DE ALUMINIO Y POLIETILENO FONDO 300

STRAIGHT ALUMINUM AND POLYETHYLENE SHELVES DEPTH 300
ÉTAGÈRES DROITES EN ALUMINIUM ET POLYÉTHYLÈNE PROFONDEUR 300

Estructura de aluminio. Inoxidable y de gran robustez con cuatro travesaños de unión. ALTURA 1700 mm. Estantes de poliuretano alimentario inyectado a baja presión lavables en lavavajillas regulables cada 150 mm. Fácil montaje sin necesidad de herramientas. Capacidad de carga 150 Kg. por estante.

Aluminum frame. Stainless and highly robust with four connecting crossbars. Height 1700 mm. Shelves in food-grade polyurethane injected at low pressure, dishwasher safe, adjustable every 150 mm. Easy assembly without tools. Load capacity 150 Kg. Per shelf.



3 ESTANTES 4 ESTANTES 5 ESTANTES

LONGITUD TOTAL	COMPOSICIÓN ESTANTES	Nº SOPORTES	CÓDIGO	PRECIO	CÓDIGO	PRECIO	CÓDIGO	PRECIO
687	60	1	EA0687R33	294 €	EA0687R43	341 €	EA0687R53	389 €
787	70		EA0787R33	311 €	EA0787R43	365 €	EA0787R53	419 €
888	80		EA0888R33	321 €	EA0888R43	378 €	EA0888R53	435 €
988	90		EA0988R33	336 €	EA0988R43	397 €	EA0988R53	459 €
1088	100		EA1088R33	344 €	EA1088R43	409 €	EA1088R53	474 €
1188	110		EA1188R33	361 €	EA1188R43	431 €	EA1188R53	502 €
1289	120		EA1289R33	381 €	EA1289R43	457 €	EA1289R53	534 €
1389	130		EA1389R33	389 €	EA1389R43	469 €	EA1389R53	549 €
1489	140		EA1489R33	408 €	EA1489R43	494 €	EA1489R53	580 €
1589	15		EA1589R33	425 €	EA1589R43	516 €	EA1589R53	608 €
1690	160		EA1690R33	436 €	EA1690R43	532 €	EA1690R53	627 €
1722	100+60		EA1722R33	546 €	EA1722R43	655 €	EA1722R53	764 €
1822	100+70		EA1822R33	564 €	EA1822R43	679 €	EA1822R53	793 €
1922	10+80		EA1922R33	573 €	EA1922R43	691 €	EA1922R53	809 €
2022	100+90		EA2022R33	588 €	EA2022R43	711 €	EA2022R53	834 €
2122	100+100		EA2122R33	597 €	EA2122R43	723 €	EA2122R53	848 €
2222	110+100		EA2222R33	614 €	EA2222R43	745 €	EA2222R53	876 €
2323	110+110	EA2323R33	630 €	EA2323R43	767 €	EA2323R53	904 €	
2423	120+110	EA2423R33	650 €	EA2423R43	793 €	EA2423R53	936 €	
2524	120+120	EA2524R33	669 €	EA2524R43	819 €	EA2524R53	969 €	
2624	130+120	EA2624R33	678 €	EA2624R43	831 €	EA2624R53	984 €	
2724	130+130	EA2724R33	687 €	EA2724R43	843 €	EA2724R53	998 €	
2824	140+130	EA2824R33	706 €	EA2824R43	868 €	EA2824R53	1.030 €	
2924	140+140	EA2924R33	724 €	EA2924R43	892 €	EA2924R53	1.061 €	
3024	150+140	EA3024R33	741 €	EA3024R43	915 €	EA3024R53	1.088 €	
3125	150+150	EA3125R33	758 €	EA3125R43	937 €	EA3125R53	1.116 €	
3225	160+150	EA3225R33	769 €	EA3225R43	952 €	EA3225R53	1.136 €	
3326	160+160	EA3326R33	781 €	EA3326R43	968 €	EA3326R53	1.155 €	
3458	110+110+110	EA3458R33	900 €	EA3458R43	1.103 €	EA3458R53	1.306 €	
3558	120+110+110	EA3558R33	919 €	EA3558R43	1.129 €	EA3558R53	1.339 €	
3658	120+120+110	EA3658R33	938 €	EA3658R43	1.155 €	EA3658R53	1.371 €	
3759	120+120+120	EA3759R33	958 €	EA3759R43	1.181 €	EA3759R53	1.403 €	
3859	130+120+120	EA3859R33	967 €	EA3859R43	1.192 €	EA3859R53	1.418 €	
3959	130+130+120	EA3959R33	976 €	EA3959R43	1.204 €	EA3959R53	1.433 €	
4059	130+130+130	EA4059R33	985 €	EA4059R43	1.216 €	EA4059R53	1.448 €	
4159	140+130+130	EA4159R33	1.003 €	EA4159R43	1.241 €	EA4159R53	1.479 €	
4259	140+140+130	EA4259R33	1.022 €	EA4259R43	1.266 €	EA4259R53	1.510 €	
4359	140+140+140	EA4359R33	1.041 €	EA4359R43	1.291 €	EA4359R53	1.541 €	
4460	150+140+140	EA4460R33	1.057 €	EA4460R43	1.313 €	EA4460R53	1.569 €	
4560	150+150+140	EA4560R33	1.074 €	EA4560R43	1.335 €	EA4560R53	1.597 €	
4660	150+150+150	EA4660R33	1.091 €	EA4660R43	1.358 €	EA4660R53	1.625 €	
4761	160+150+150	EA4761R33	1.102 €	EA4761R43	1.373 €	EA4761R53	1.644 €	
4861	160+160+150	EA4861R33	1.114 €	EA4861R43	1.389 €	EA4861R53	1.663 €	
4962	160+160+160	EA4962R33	1.126 €	EA4962R43	1.404 €	EA4962R53	1.683 €	
5094	130+120+120+120	EA5094R33	1.255 €	EA5094R43	1.554 €	EA5094R53	1.853 €	
5194	130+130+120+120	EA5194R33	1.264 €	EA5194R43	1.566 €	EA5194R53	1.867 €	
5294	130+130+130+120	EA5294R33	1.273 €	EA5294R43	1.578 €	EA5294R53	1.882 €	
5394	130+130+130+130	EA5394R33	1.282 €	EA5394R43	1.590 €	EA5394R53	1.897 €	
5494	140+130+130+130	EA5494R33	1.301 €	EA5494R43	1.615 €	EA5494R53	1.928 €	
5594	140+140+130+130	EA5594R33	1.319 €	EA5594R43	1.639 €	EA5594R53	1.959 €	
5694	140+140+140+130	EA5694R33	1.338 €	EA5694R43	1.664 €	EA5694R53	1.991 €	
5794	140+140+140+140	EA5794R33	1.357 €	EA5794R43	1.689 €	EA5794R53	2.022 €	
5894	150+140+140+140	EA5894R33	1.373 €	EA5894R43	1.711 €	EA5894R53	2.049 €	
5995	150+150+140+140	EA5995R33	1.390 €	EA5995R43	1.734 €	EA5995R53	2.077 €	
6096	150+150+150+140	EA6096R33	1.407 €	EA6096R43	1.756 €	EA6096R53	2.105 €	
6196	150+150+150+150	EA6196R33	1.424 €	EA6196R43	1.778 €	EA6196R53	2.133 €	
6296	160+150+150+150	EA6296R33	1.435 €	EA6296R43	1.794 €	EA6296R53	2.152 €	
6397	160+160+150+150	EA6397R33	1.447 €	EA6397R43	1.809 €	EA6397R53	2.172 €	
6497	160+160+160+150	EA6497R33	1.458 €	EA6497R43	1.825 €	EA6497R53	2.191 €	
6598	160+160+160+160	EA6598R33	1.470 €	EA6598R43	1.840 €	EA6598R53	2.210 €	

ESTANTERÍAS ANGULARES DE ALUMINIO Y POLIETILENO FONDO 300

ANGULAR ALUMINUM AND POLYETHYLENE SHELVES DEPTH 300
ÉTAGÈRES ANGULAIRE EN ALUMINIUM ET POLYÉTHYLÈNE PROFONDEUR 300

Cadre en aluminium. Inoxydable et très robuste avec quatre traverses de connexion. Hauteur 1700 mm. Clayettes en polyuréthane alimentaire injecté à basse pression, lavables au lave-vaisselle, réglables tous les 150 mm. Assemblage facile sans outils. Capacité de charge 150 Kg. Par étagère.



3 ESTANTES 4 ESTANTES 5 ESTANTES

LONGITUD TOTAL	COMPOSICIÓN ESTANTES	Nº SOPORTES	CÓDIGO	PRECIO	CÓDIGO	PRECIO	CÓDIGO	PRECIO
644	60	1	EA0644A33	246 €	EA0644A43	301 €	EA0644A53	356 €
744	70		EA0744A33	264 €	EA0744A43	325 €	EA0744A53	386 €
845	80		EA0845A33	273 €	EA0845A43	337 €	EA0845A53	402 €
945	90		EA0945A33	288 €	EA0945A43	357 €	EA0945A53	426 €
1045	100		EA1045A33	297 €	EA1045A43	369 €	EA1045A53	441 €
1145	110		EA1145A33	313 €	EA1145A43	391 €	EA1145A53	469 €
1246	120		EA1246A33	333 €	EA1246A43	417 €	EA1246A53	501 €
1346	130		EA1346A33	342 €	EA1346A43	429 €	EA1346A53	516 €
1446	140		EA1446A33	360 €	EA1446A43	454 €	EA1446A53	547 €
1546	15		EA1546A33	377 €	EA1546A43	476 €	EA1546A53	575 €
1647	160		EA1647A33	389 €	EA1647A43	492 €	EA1647A53	594 €
1679	100+60		EA1679A33	498 €	EA1679A43	615 €	EA1679A53	731 €
1779	100+70		EA1779A33	516 €	EA1779A43	638 €	EA1779A53	760 €
1879	10+80		EA1879A33	526 €	EA1879A43	651 €	EA1879A53	776 €
1980	100+90		EA1980A33	540 €	EA1980A43	670 €	EA1980A53	801 €
2080	100+100		EA2080A33	549 €	EA2080A43	682 €	EA2080A53	815 €
2180	110+100		EA2180A33	566 €	EA2180A43	705 €	EA2180A53	843 €
2280	110+110	EA2280A33	583 €	EA2280A43	727 €	EA2280A53	871 €	
2380	120+110	EA2380A33	602 €	EA2380A43	753 €	EA2380A53	903 €	
2480	120+120	EA2480A33	621 €	EA2480A43	779 €	EA2480A53	936 €	
2580	130+120	EA2580A33	630 €	EA2580A43	790 €	EA2580A53	951 €	
2680	130+130	EA2680A33	639 €	EA2680A43	802 €	EA2680A53	965 €	
2781	140+130	EA2781A33	658 €	EA2781A43	827 €	EA2781A53	997 €	
2881	140+140	EA2881A33	677 €	EA2881A43	852 €	EA2881A53	1.028 €	
2982	150+140	EA2982A33	693 €	EA2982A43	874 €	EA2982A53	1.055 €	
3082	150+150	EA3082A33	710 €	EA3082A43	897 €	EA3082A53	1.083 €	
3183	160+150	EA3183A33	722 €	EA3183A43	912 €	EA3183A53	1.103 €	
3283	160+160	EA3283A33	733 €	EA3283A43	928 €	EA3283A53	1.122 €	
3412	110+110+110	EA3412A33	852 €	EA3412A43	1.063 €	EA3412A53	1.273 €	
3514	120+110+110	EA3514A33	871 €	EA3514A43	1.088 €	EA3514A53	1.306 €	
3614	120+120+110	EA3614A33	891 €	EA3614A43	1.114 €	EA3614A53	1.338 €	
3716	120+120+120	EA3716A33	910 €	EA3716A43	1.140 €	EA3716A53	1.370 €	
3816	130+120+120	EA3816A33	919 €	EA3816A43	1.152 €	EA3816A53	1.385 €	
3916	130+130+120	EA3916A33	928 €	EA3916A43	1.164 €	EA3916A53	1.400 €	
4016	130+130+130	EA4016A33	937 €	EA4016A43	1.176 €	EA4016A53	1.415 €	
4116	140+130+130	EA4116A33	956 €	EA4116A43	1.201 €	EA4116A53	1.446 €	
4216	140+140+130	EA4216A33	974 €	EA4216A43	1.226 €	EA4216A53	1.477 €	
4316	140+140+140	EA4316A33	993 €	EA4316A43	1.250 €	EA4316A53	1.508 €	
4417	150+140+140	EA4417A33	1.010 €	EA4417A43	1.273 €	EA4417A53	1.536 €	
4517	150+150+140	EA4517A33	1.026 €	EA4517A43	1.295 €	EA4517A53	1.564 €	
4617	150+150+150	EA4617A33	1.043 €	EA4617A43	1.317 €	EA4617A53	1.591 €	
4718	160+150+150	EA4718A33	1.055 €	EA4718A43	1.333 €	EA4718A53	1.611 €	
4818	160+160+150	EA4818A33	1.066 €	EA4818A43	1.348 €	EA4818A53	1.630 €	
4918	160+160+160	EA4918A33	1.078 €	EA4918A43	1.364 €	EA4918A53	1.650 €	
5050	130+120+120+120	EA5050A33	1.208 €	EA5050A43	1.514 €	EA5050A53	1.820 €	
5151	130+130+120+120	EA5151A33	1.217 €	EA5151A43	1.526 €	EA5151A53	1.834 €	
5251	130+130+130+120	EA5251A33	1.226 €	EA5251A43	1.537 €	EA5251A53	1.849 €	
5351	130+130+130+130	EA5351A33	1.234 €	EA5351A43	1.549 €	EA5351A53	1.864 €	
5451	140+130+130+130	EA5451A33	1.253 €	EA5451A43	1.574 €	EA5451A53	1.895 €	
5551	140+140+130+130	EA5551A33	1.272 €	EA5551A43	1.599 €	EA5551A53	1.926 €	
5651	140+140+140+130	EA5651A33	1.290 €	EA5651A43	1.624 €	EA5651A53	1.957 €	
5751	140+140+140+140	EA5751A33	1.309 €	EA5751A43	1.649 €	EA5751A53	1.989 €	
5852	150+140+140+140	EA5852A33	1.326 €	EA5852A43	1.671 €	EA5852A53	2.016 €	
5952	150+150+140+140	EA5952A33	1.342 €	EA5952A43	1.693 €	EA5952A53	2.044 €	
6053	150+150+150+140	EA6053A33	1.359 €	EA6053A43	1.716 €	EA6053A53	2.072 €	
6153	150+150+150+150	EA6153A33	1.376 €	EA6153A43	1.738 €	EA6153A53	2.100 €</	

ESTANTERÍAS RECTAS DE ALUMINIO Y POLIETILENO FONDO 400

STRAIGHT ALUMINUM AND POLYETHYLENE SHELVES DEPTH 400
ÉTAGÈRES DROITES EN ALUMINIUM ET POLYÉTHYLÈNE PROFONDEUR 400

Estructura de aluminio. Inoxidable y de gran robustez con cuatro travesaños de unión. ALTURA 1700 mm. Estantes de poliuretano alimentario inyectado a baja presión lavables en lavavajillas regulables cada 150 mm. Fácil montaje sin necesidad de herramientas. Capacidad de carga 150 Kg. por estante.

Aluminum frame. Stainless and highly robust with four connecting crossbars. Height 1700 mm. Shelves in food-grade polyurethane injected at low pressure, dishwasher safe, adjustable every 150 mm. Easy assembly without tools. Load capacity 150 Kg. Per shelf.



LONGITUD TOTAL	COMPOSICIÓN ESTANTES	Nº SOPORTES	3 ESTANTES		4 ESTANTES		5 ESTANTES	
			CÓDIGO	PRECIO	CÓDIGO	PRECIO	CÓDIGO	PRECIO
687	60	1	EA0687R34	294 €	EA0687R44	341 €	EA0687R54	389 €
787	70		EA0787R34	311 €	EA0787R44	365 €	EA0787R54	419 €
888	80		EA0888R34	321 €	EA0888R44	378 €	EA0888R54	435 €
988	90		EA0988R34	336 €	EA0988R44	397 €	EA0988R54	459 €
1088	100		EA1088R34	346 €	EA1088R44	411 €	EA1088R54	476 €
1188	110		EA1188R34	361 €	EA1188R44	431 €	EA1188R54	502 €
1289	120		EA1289R34	381 €	EA1289R44	457 €	EA1289R54	534 €
1389	130		EA1389R34	389 €	EA1389R44	469 €	EA1389R54	549 €
1489	140		EA1489R34	408 €	EA1489R44	494 €	EA1489R54	580 €
1589	150		EA1589R34	425 €	EA1589R44	516 €	EA1589R54	608 €
1690	160		EA1690R34	436 €	EA1690R44	532 €	EA1690R54	627 €
1722	100+60		EA1722R34	547 €	EA1722R44	657 €	EA1722R54	766 €
1822	100+70		EA1822R34	565 €	EA1822R44	680 €	EA1822R54	795 €
1922	10+80		EA1922R34	575 €	EA1922R44	693 €	EA1922R54	811 €
2022	100+90		EA2022R34	589 €	EA2022R44	712 €	EA2022R54	836 €
2122	100+100		EA2122R34	599 €	EA2122R44	726 €	EA2122R54	852 €
2222	110+100		EA2222R34	615 €	EA2222R44	747 €	EA2222R54	878 €
2323	110+110	EA2323R34	630 €	EA2323R44	767 €	EA2323R54	904 €	
2423	120+110	EA2423R34	650 €	EA2423R44	793 €	EA2423R54	936 €	
2524	120+120	EA2524R34	669 €	EA2524R44	819 €	EA2524R54	969 €	
2624	130+120	EA2624R34	678 €	EA2624R44	831 €	EA2624R54	984 €	
2724	130+130	EA2724R34	687 €	EA2724R44	843 €	EA2724R54	998 €	
2824	140+130	EA2824R34	706 €	EA2824R44	868 €	EA2824R54	1.030 €	
2924	140+140	EA2924R34	724 €	EA2924R44	892 €	EA2924R54	1.061 €	
3024	150+140	EA3024R34	741 €	EA3024R44	915 €	EA3024R54	1.088 €	
3125	150+150	EA3125R34	758 €	EA3125R44	937 €	EA3125R54	1.116 €	
3225	160+150	EA3225R34	769 €	EA3225R44	952 €	EA3225R54	1.136 €	
3326	160+160	EA3326R34	781 €	EA3326R44	968 €	EA3326R54	1.155 €	
3458	110+110+110	EA3458R34	900 €	EA3458R44	1.103 €	EA3458R54	1.306 €	
3558	120+110+110	EA3558R34	919 €	EA3558R44	1.129 €	EA3558R54	1.339 €	
3658	120+120+110	EA3658R34	938 €	EA3658R44	1.155 €	EA3658R54	1.371 €	
3759	120+120+120	EA3759R34	958 €	EA3759R44	1.181 €	EA3759R54	1.403 €	
3859	130+120+120	EA3859R34	967 €	EA3859R44	1.192 €	EA3859R54	1.418 €	
3959	130+130+120	EA3959R34	976 €	EA3959R44	1.204 €	EA3959R54	1.433 €	
4059	130+130+130	EA4059R34	985 €	EA4059R44	1.216 €	EA4059R54	1.448 €	
4159	140+130+130	EA4159R34	1.003 €	EA4159R44	1.241 €	EA4159R54	1.479 €	
4259	140+140+130	EA4259R34	1.022 €	EA4259R44	1.266 €	EA4259R54	1.510 €	
4359	140+140+140	EA4359R34	1.041 €	EA4359R44	1.291 €	EA4359R54	1.541 €	
4460	150+140+140	EA4460R34	1.057 €	EA4460R44	1.313 €	EA4460R54	1.569 €	
4560	150+150+140	EA4560R34	1.074 €	EA4560R44	1.335 €	EA4560R54	1.597 €	
4660	150+150+150	EA4660R34	1.091 €	EA4660R44	1.358 €	EA4660R54	1.625 €	
4761	160+150+150	EA4761R34	1.102 €	EA4761R44	1.373 €	EA4761R54	1.644 €	
4861	160+160+150	EA4861R34	1.114 €	EA4861R44	1.389 €	EA4861R54	1.663 €	
4962	160+160+160	EA4962R34	1.126 €	EA4962R44	1.404 €	EA4962R54	1.683 €	
5094	130+120+120+120	EA5094R34	1.255 €	EA5094R44	1.554 €	EA5094R54	1.853 €	
5194	130+130+120+120	EA5194R34	1.264 €	EA5194R44	1.566 €	EA5194R54	1.867 €	
5294	130+130+130+120	EA5294R34	1.273 €	EA5294R44	1.578 €	EA5294R54	1.882 €	
5394	130+130+130+130	EA5394R34	1.282 €	EA5394R44	1.590 €	EA5394R54	1.897 €	
5494	140+130+130+130	EA5494R34	1.301 €	EA5494R44	1.615 €	EA5494R54	1.928 €	
5594	140+140+130+130	EA5594R34	1.319 €	EA5594R44	1.639 €	EA5594R54	1.959 €	
5694	140+140+140+130	EA5694R34	1.338 €	EA5694R44	1.664 €	EA5694R54	1.991 €	
5794	140+140+140+140	EA5794R34	1.357 €	EA5794R44	1.689 €	EA5794R54	2.022 €	
5894	150+140+140+140	EA5894R34	1.373 €	EA5894R44	1.711 €	EA5894R54	2.049 €	
5995	150+150+140+140	EA5995R34	1.390 €	EA5995R44	1.734 €	EA5995R54	2.077 €	
6096	150+150+150+140	EA6096R34	1.407 €	EA6096R44	1.756 €	EA6096R54	2.105 €	
6196	150+150+150+150	EA6196R34	1.424 €	EA6196R44	1.778 €	EA6196R54	2.133 €	
6296	160+150+150+150	EA6296R34	1.435 €	EA6296R44	1.794 €	EA6296R54	2.152 €	
6397	160+160+150+150	EA6397R34	1.447 €	EA6397R44	1.809 €	EA6397R54	2.172 €	
6497	160+160+160+150	EA6497R34	1.458 €	EA6497R44	1.825 €	EA6497R54	2.191 €	
6598	160+160+160+160	EA6598R34	1.470 €	EA6598R44	1.840 €	EA6598R54	2.210 €	

ESTANTERÍAS ANGULARES DE ALUMINIO Y POLIETILENO FONDO 400

ANGULAR ALUMINUM AND POLYETHYLENE SHELVES DEPTH 400
ÉTAGÈRES ANGULAIRE EN ALUMINIUM ET POLYÉTHYLÈNE PROFONDEUR 400

Cadre en aluminium. Inoxydable et très robuste avec quatre traverses de connexion. Hauteur 1700 mm. Clayettes en polyuréthane alimentaire injecté à basse pression, lavables au lave-vaisselle, réglables tous les 150 mm. Assemblage facile sans outils. Capacité de charge 150 Kg. Par étagère.



LONGITUD TOTAL	COMPOSICIÓN ESTANTES	Nº SOPORTES	3 ESTANTES		4 ESTANTES		5 ESTANTES	
			CÓDIGO	PRECIO	CÓDIGO	PRECIO	CÓDIGO	PRECIO
644	60	1	EA0644A34	246 €	EA0644A44	301 €	EA0644A54	356 €
744	70		EA0744A34	264 €	EA0744A44	325 €	EA0744A54	386 €
845	80		EA0845A34	273 €	EA0845A44	337 €	EA0845A54	402 €
945	90		EA0945A34	288 €	EA0945A44	357 €	EA0945A54	426 €
1045	100		EA1045A34	298 €	EA1045A44	370 €	EA1045A54	443 €
1145	110		EA1145A34	313 €	EA1145A44	391 €	EA1145A54	469 €
1246	120		EA1246A34	333 €	EA1246A44	417 €	EA1246A54	501 €
1346	130		EA1346A34	342 €	EA1346A44	429 €	EA1346A54	516 €
1446	140		EA1446A34	360 €	EA1446A44	454 €	EA1446A54	547 €
1546	150		EA1546A34	377 €	EA1546A44	476 €	EA1546A54	575 €
1647	160		EA1647A34	389 €	EA1647A44	492 €	EA1647A54	594 €
1679	100+60		EA1679A34	500 €	EA1679A44	616 €	EA1679A54	733 €
1779	100+70		EA1779A34	517 €	EA1779A44	640 €	EA1779A54	762 €
1879	10+80		EA1879A34	527 €	EA1879A44	652 €	EA1879A54	778 €
1980	100+90		EA1980A34	542 €	EA1980A44	672 €	EA1980A54	802 €
2080	100+100		EA2080A34	552 €	EA2080A44	685 €	EA2080A54	819 €
2180	110+100		EA2180A34	567 €	EA2180A44	706 €	EA2180A54	845 €
2280	110+110	EA2280A34	583 €	EA2280A44	727 €	EA2280A54	871 €	
2380	120+110	EA2380A34	602 €	EA2380A44	753 €	EA2380A54	903 €	
2480	120+120	EA2480A34	621 €	EA2480A44	779 €	EA2480A54	936 €	
2580	130+120	EA2580A34	630 €	EA2580A44	790 €	EA2580A54	951 €	
2680	130+130	EA2680A34	639 €	EA2680A44	802 €	EA2680A54	965 €	
2781	140+130	EA2781A34	658 €	EA2781A44	827 €	EA2781A54	997 €	
2881	140+140	EA2881A34	677 €	EA2881A44	852 €	EA2881A54	1.028 €	
2982	150+140	EA2982A34	693 €	EA2982A44	874 €	EA2982A54	1.055 €	
3082	150+150	EA3082A34	710 €	EA3082A44	897 €	EA3082A54	1.083 €	
3183	160+150	EA3183A34	722 €	EA3183A44	912 €	EA3183A54	1.103 €	
3283	160+160	EA3283A34	733 €	EA3283A44	928 €	EA3283A54	1.122 €	
3412	110+110+110	EA3412A34	852 €	EA3412A44	1.063 €	EA3412A54	1.273 €	
3514	120+110+110	EA3514A34	871 €	EA3514A44	1.088 €	EA3514A54	1.306 €	
3614	120+120+110	EA3614A34	891 €	EA3614A44	1.114 €	EA3614A54	1.338 €	
3716	120+120+120	EA3716A34	910 €	EA3716A44	1.140 €	EA3716A54	1.370 €	
3816	130+120+120	EA3816A34	919 €	EA3816A44	1.152 €	EA3816A54	1.385 €	
3916	130+130+120	EA3916A34	928 €	EA3916A44	1.164 €	EA3916A54	1.400 €	
4016	130+130+130	EA4016A34	937 €	EA4016A44	1.176 €	EA4016A54	1.415 €	
4116	140+130+130	EA4116A34	956 €	EA4116A44	1.201 €	EA4116A54	1.446 €	
4216	140+140+130	EA4216A34	974 €	EA4216A44	1.226 €	EA4216A54	1.477 €	
4316	140+140+140	EA4316A34	993 €	EA4316A44	1.250 €	EA4316A54	1.508 €	
4417	150+140+140	EA4417A34	1.010 €	EA4417A44	1.273 €	EA4417A54	1.536 €	
4517	150+150+140	EA4517A34	1.026 €	EA4517A44	1.295 €	EA4517A54	1.564 €	
4617	150+150+150	EA4617A34	1.043 €	EA4617A44	1.317 €	EA4617A54	1.591 €	
4718	160+150+150	EA4718A34	1.055 €	EA4718A44	1.333 €	EA4718A54	1.611 €	
4818	160+160+150	EA4818A34	1.066 €	EA4818A44	1.348 €	EA4818A54	1.630 €	
4918	160+160+160	EA4918A34	1.078 €	EA4918A44	1.364 €	EA4918A54	1.650 €	
5050	130+120+120+120	EA5050A34	1.208 €	EA5050A44	1.514 €	EA5050A54	1.820 €	
5151	130+130+120+120	EA5151A34	1.217 €	EA5151A44	1.526 €	EA5151A54	1.834 €	
5251	130+130+130+120	EA5251A34	1.226 €	EA5251A44	1.537 €	EA5251A54	1.849 €	
5351	130+130+130+130	EA5351A34	1.234 €	EA5351A44	1.549 €	EA5351A54	1.864 €	
5451	140+130+130+130	EA5451A34	1.253 €	EA5451A44	1.574 €	EA5451A54	1.895 €	
5551	140+140+130+130	EA5551A34	1.272 €	EA5551A44	1.599 €	EA5551A54	1.926 €	
5651	140+140+140+130	EA5651A34	1.290 €	EA5651A44	1.624 €	EA5651A54	1.957 €	
5751	140+140+140+140	EA5751A34	1.309 €	EA5751A44	1.649 €	EA5751A54	1.989 €	
5852	150+140+140+140	EA5852A34	1.326 €	EA5852A44	1.671 €	EA5852A54	2.016 €	
5952	150+150+140+140	EA5952A34	1.342 €	EA5952A44	1.693 €	EA5952A54	2.044 €	
6053	150+150+150+140	EA6053A34	1.359 €	EA6053A44	1.716 €	EA6053A54	2.072 €	
6153	150+150+150+150	EA6153A34	1.376 €	EA6153A44	1.738 €	EA6153A54		

ESTANTERÍAS RECTAS DE ALUMINIO Y POLIETILENO FONDO 500

STRAIGHT ALUMINUM AND POLYETHYLENE SHELVES DEPTH 500
ÉTAGÈRES DROITES EN ALUMINIUM ET POLYÉTHYLÈNE PROFONDEUR 500

Estructura de aluminio. Inoxidable y de gran robustez con cuatro travesaños de unión. ALTURA 1700 mm. Estantes de poliuretano alimentario inyectado a baja presión lavables en lavavajillas regulables cada 150 mm. Fácil montaje sin necesidad de herramientas. Capacidad de carga 150 Kg. por estante.

Aluminum frame. Stainless and highly robust with four connecting crossbars. Height 1700 mm. Shelves in food-grade polyurethane injected at low pressure, dishwasher safe, adjustable every 150 mm. Easy assembly without tools. Load capacity 150 Kg. Per shelf.



3 ESTANTES 4 ESTANTES 5 ESTANTES

LONGITUD TOTAL	COMPOSICIÓN ESTANTES	Nº SOPORTES	CÓDIGO	PRECIO	CÓDIGO	PRECIO	CÓDIGO	PRECIO
687	60	1	EA0687R35	312 €	EA0687R45	364 €	EA0687R55	417 €
787	70		EA0787R35	328 €	EA0787R45	386 €	EA0787R55	444 €
888	80		EA0888R35	340 €	EA0888R45	402 €	EA0888R55	464 €
988	90		EA0988R35	357 €	EA0988R45	424 €	EA0988R55	492 €
1088	100		EA1088R35	367 €	EA1088R45	438 €	EA1088R55	508 €
1188	110		EA1188R35	386 €	EA1188R45	463 €	EA1188R55	539 €
1289	120		EA1289R35	396 €	EA1289R45	476 €	EA1289R55	556 €
1389	130		EA1389R35	419 €	EA1389R45	507 €	EA1389R55	595 €
1489	140		EA1489R35	435 €	EA1489R45	528 €	EA1489R55	621 €
1589	150		EA1589R35	452 €	EA1589R45	551 €	EA1589R55	649 €
1690	160		EA1690R35	465 €	EA1690R45	568 €	EA1690R55	671 €
1722	100+60		EA1722R35	585 €	EA1722R45	704 €	EA1722R55	823 €
1822	100+70		EA1822R35	601 €	EA1822R45	725 €	EA1822R55	850 €
1922	10+80		EA1922R35	613 €	EA1922R45	741 €	EA1922R55	870 €
2022	100+90		EA2022R35	630 €	EA2022R45	764 €	EA2022R55	898 €
2122	100+100		EA2122R35	640 €	EA2122R45	777 €	EA2122R55	914 €
2222	110+100	EA2222R35	658 €	EA2222R45	802 €	EA2222R55	945 €	
2323	110+110	EA2323R35	677 €	EA2323R45	827 €	EA2323R55	976 €	
2423	120+110	EA2423R35	687 €	EA2423R45	840 €	EA2423R55	993 €	
2524	120+120	EA2524R35	697 €	EA2524R45	854 €	EA2524R55	1.010 €	
2624	130+120	EA2624R35	720 €	EA2624R45	885 €	EA2624R55	1.049 €	
2724	130+130	EA2724R35	744 €	EA2724R45	916 €	EA2724R55	1.088 €	
2824	140+130	EA2824R35	760 €	EA2824R45	937 €	EA2824R55	1.114 €	
2924	140+140	EA2924R35	776 €	EA2924R45	958 €	EA2924R55	1.141 €	
3024	150+140	EA3024R35	792 €	EA3024R45	980 €	EA3024R55	1.169 €	
3125	150+150	EA3125R35	809 €	EA3125R45	1.003 €	EA3125R55	1.196 €	
3225	160+150	EA3225R35	822 €	EA3225R45	1.020 €	EA3225R55	1.218 €	
3326	160+160	EA3326R35	835 €	EA3326R45	1.038 €	EA3326R55	1.240 €	
3458	110+110+110	EA3458R35	968 €	EA3458R45	1.191 €	EA3458R55	1.414 €	
3558	120+110+110	EA3558R35	978 €	EA3558R45	1.204 €	EA3558R55	1.430 €	
3658	120+120+110	EA3658R35	988 €	EA3658R45	1.218 €	EA3658R55	1.447 €	
3759	120+120+120	EA3759R35	999 €	EA3759R45	1.231 €	EA3759R55	1.464 €	
3859	130+120+120	EA3859R35	1.022 €	EA3859R45	1.262 €	EA3859R55	1.503 €	
3959	130+130+120	EA3959R35	1.045 €	EA3959R45	1.293 €	EA3959R55	1.542 €	
4059	130+130+130	EA4059R35	1.068 €	EA4059R45	1.325 €	EA4059R55	1.581 €	
4159	140+130+130	EA4159R35	1.084 €	EA4159R45	1.346 €	EA4159R55	1.607 €	
4259	140+140+130	EA4259R35	1.100 €	EA4259R45	1.367 €	EA4259R55	1.634 €	
4359	140+140+140	EA4359R35	1.116 €	EA4359R45	1.388 €	EA4359R55	1.660 €	
4460	150+140+140	EA4460R35	1.133 €	EA4460R45	1.410 €	EA4460R55	1.688 €	
4560	150+150+140	EA4560R35	1.150 €	EA4560R45	1.433 €	EA4560R55	1.716 €	
4660	150+150+150	EA4660R35	1.166 €	EA4660R45	1.455 €	EA4660R55	1.744 €	
4761	160+150+150	EA4761R35	1.179 €	EA4761R45	1.472 €	EA4761R55	1.766 €	
4861	160+160+150	EA4861R35	1.193 €	EA4861R45	1.490 €	EA4861R55	1.788 €	
4962	160+160+160	EA4962R35	1.206 €	EA4962R45	1.508 €	EA4962R55	1.810 €	
5094	130+120+120+120	EA5094R35	1.323 €	EA5094R45	1.640 €	EA5094R55	1.957 €	
5194	130+130+120+120	EA5194R35	1.346 €	EA5194R45	1.671 €	EA5194R55	1.996 €	
5294	130+130+130+120	EA5294R35	1.370 €	EA5294R45	1.702 €	EA5294R55	2.035 €	
5394	130+130+130+130	EA5394R35	1.393 €	EA5394R45	1.733 €	EA5394R55	2.073 €	
5494	140+130+130+130	EA5494R35	1.409 €	EA5494R45	1.754 €	EA5494R55	2.100 €	
5594	140+140+130+130	EA5594R35	1.425 €	EA5594R45	1.776 €	EA5594R55	2.126 €	
5694	140+140+140+130	EA5694R35	1.441 €	EA5694R45	1.797 €	EA5694R55	2.153 €	
5794	140+140+140+140	EA5794R35	1.457 €	EA5794R45	1.818 €	EA5794R55	2.179 €	
5894	150+140+140+140	EA5894R35	1.473 €	EA5894R45	1.840 €	EA5894R55	2.207 €	
5995	150+150+140+140	EA5995R35	1.490 €	EA5995R45	1.863 €	EA5995R55	2.235 €	
6096	150+150+150+140	EA6096R35	1.507 €	EA6096R45	1.885 €	EA6096R55	2.263 €	
6196	150+150+150+150	EA6196R35	1.523 €	EA6196R45	1.907 €	EA6196R55	2.291 €	
6296	160+150+150+150	EA6296R35	1.537 €	EA6296R45	1.925 €	EA6296R55	2.313 €	
6397	160+160+150+150	EA6397R35	1.550 €	EA6397R45	1.942 €	EA6397R55	2.335 €	
6497	160+160+160+150	EA6497R35	1.563 €	EA6497R45	1.960 €	EA6497R55	2.357 €	
6598	160+160+160+160	EA6598R35	1.576 €	EA6598R45	1.977 €	EA6598R55	2.379 €	

ESTANTERÍAS ANGULARES DE ALUMINIO Y POLIETILENO FONDO 500

ANGULAR ALUMINUM AND POLYETHYLENE SHELVES DEPTH 500
ÉTAGÈRES ANGULAIRE EN ALUMINIUM ET POLYÉTHYLÈNE PROFONDEUR 500

Cadre en aluminium. Inoxydable et très robuste avec quatre traverses de connexion. Hauteur 1700 mm. Clayettes en polyuréthane alimentaire injecté à basse pression, lavables au lave-vaisselle, réglables tous les 150 mm. Assemblage facile sans outils. Capacité de charge 150 Kg. Par étagère.



3 ESTANTES 4 ESTANTES 5 ESTANTES

LONGITUD TOTAL	COMPOSICIÓN ESTANTES	Nº SOPORTES	CÓDIGO	PRECIO	CÓDIGO	PRECIO	CÓDIGO	PRECIO
644	60	1	EA0644A35	262 €	EA0644A45	321 €	EA0644A55	381 €
744	70		EA0744A35	278 €	EA0744A45	343 €	EA0744A55	408 €
845	80		EA0845A35	290 €	EA0845A45	359 €	EA0845A55	428 €
945	90		EA0945A35	307 €	EA0945A45	381 €	EA0945A55	456 €
1045	100		EA1045A35	317 €	EA1045A45	395 €	EA1045A55	473 €
1145	110		EA1145A35	335 €	EA1145A45	420 €	EA1145A55	504 €
1246	120		EA1246A35	345 €	EA1246A45	433 €	EA1246A55	521 €
1346	130		EA1346A35	369 €	EA1346A45	464 €	EA1346A55	559 €
1446	140		EA1446A35	385 €	EA1446A45	485 €	EA1446A55	586 €
1546	150		EA1546A35	401 €	EA1546A45	508 €	EA1546A55	614 €
1647	160		EA1647A35	415 €	EA1647A45	525 €	EA1647A55	636 €
1679	100+60		EA1679A35	534 €	EA1679A45	661 €	EA1679A55	787 €
1779	100+70		EA1779A35	551 €	EA1779A45	682 €	EA1779A55	814 €
1879	10+80		EA1879A35	563 €	EA1879A45	698 €	EA1879A55	834 €
1980	100+90		EA1980A35	579 €	EA1980A45	721 €	EA1980A55	862 €
2080	100+100		EA2080A35	589 €	EA2080A45	734 €	EA2080A55	879 €
2180	110+100	EA2180A35	608 €	EA2180A45	759 €	EA2180A55	910 €	
2280	110+110	EA2280A35	627 €	EA2280A45	784 €	EA2280A55	941 €	
2380	120+110	EA2380A35	637 €	EA2380A45	797 €	EA2380A55	958 €	
2480	120+120	EA2480A35	647 €	EA2480A45	811 €	EA2480A55	974 €	
2580	130+120	EA2580A35	670 €	EA2580A45	842 €	EA2580A55	1.013 €	
2680	130+130	EA2680A35	693 €	EA2680A45	873 €	EA2680A55	1.052 €	
2781	140+130	EA2781A35	709 €	EA2781A45	894 €	EA2781A55	1.079 €	
2881	140+140	EA2881A35	725 €	EA2881A45	915 €	EA2881A55	1.105 €	
2982	150+140	EA2982A35	742 €	EA2982A45	937 €	EA2982A55	1.133 €	
3082	150+150	EA3082A35	759 €	EA3082A45	960 €	EA3082A55	1.161 €	
3183	160+150	EA3183A35	772 €	EA3183A45	977 €	EA3183A55	1.183 €	
3283	160+160	EA3283A35	785 €	EA3283A45	995 €	EA3283A55	1.205 €	
3412	110+110+110	EA3412A35	918 €	EA3412A45	1.148 €	EA3412A55	1.378 €	
3514	120+110+110	EA3514A35	928 €	EA3514A45	1.161 €	EA3514A55	1.395 €	
3614	120+120+110	EA3614A35	938 €	EA3614A45	1.175 €	EA3614A55	1.412 €	
3716	120+120+120	EA3716A35	948 €	EA3716A45	1.188 €	EA3716A55	1.428 €	
3816	130+120+120	EA3816A35	971 €	EA3816A45	1.219 €	EA3816A55	1.467 €	
3916	130+130+120	EA3916A35	995 €	EA3916A45	1.250 €	EA3916A55	1.506 €	
4016	130+130+130	EA4016A35	1.018 €	EA4016A45	1.282 €	EA4016A55	1.545 €	
4116	140+130+130	EA4116A35	1.034 €	EA4116A45	1.303 €	EA4116A55	1.572 €	
4216	140+140+130	EA4216A35	1.050 €	EA4216A45	1.324 €	EA4216A55	1.598 €	
4316	140+140+140	EA4316A35	1.066 €	EA4316A45	1.345 €	EA4316A55	1.624 €	
4417	150+140+140	EA4417A35	1.082 €	EA4417A45	1.367 €	EA4417A55	1.652 €	
4517	150+150+140	EA4517A35	1.099 €	EA4517A45	1.390 €	EA4517A55	1.680 €	
4617	150+150+150	EA4617A35	1.116 €	EA4617A45	1.412 €	EA4617A55	1.708 €	
4718	160+150+150	EA4718A35	1.129 €	EA4718A45	1.429 €	EA4718A55	1.730 €	
4818	160+160+150	EA4818A35	1.142 €	EA4818A45	1.447 €	EA4818A55	1.752 €	
4918	160+160+160	EA4918A35	1.155 €	EA4918A45	1.465 €	EA4918A55	1.774 €	
5050	130+120+120+120	EA5050A35	1.273 €	EA5050A45	1.597 €	EA5050A55	1.921 €	
5151	130+130+120+120	EA5151A35	1.296 €	EA5151A45	1.628 €	EA5151A55	1.960 €	
5251	130+130+130+120	EA5251A35	1.319 €	EA5251A45	1.659 €	EA5251A55	1.999 €	
5351	130+130+130+130	EA5351A35	1.343 €	EA5351A45	1.690 €	EA5351A55	2.038 €	
5451	140+130+130+130	EA5451A35	1.359 €	EA5451A45	1.711 €	EA5451A55	2.064 €	
5551	140+140+130+130	EA5551A35	1.375 €	EA5551A45	1.733 €	EA5551A55	2.091 €	
5651	140+140+140+130	EA5651A35	1.390 €	EA5651A45	1.754 €	EA5651A55	2.117 €	
5751	140+140+140+140	EA5751A35	1.406 €	EA5751A45	1.775 €	EA5751A55	2.144 €	
5852	150+140+140+140	EA5852A35	1.423 €	EA5852A45	1.797 €	EA5852A55	2.172 €	
5952	150+150+140+140	EA5952A35	1.440 €	EA5952A45	1.820 €	EA5952A55	2.199 €	
6053	150+150+150+140	EA6053A35	1.456 €	EA6053A45	1.842 €	EA6053A55	2.227 €	
6153	150+150+150+150	EA6153A35	1.473 €	EA6153A45				

ESTANTES DE PARED LISO

FIXED WALL SELF / ÉTAGÈRE MURALE FIXE



Totalmente fabricado en acero inoxidable AISI 304, 18/10. Frente recto de 40 mm.

Made totally of Stainless steel AISI 304, 18/10. 40 mm straight front.

Réalisées complètement en acier inoxydable AISI 304, 18/10. Front droit 40 mm.

FONDO 250

DIMENSIONES	CÓDIGO	PRECIO
1000X250	EM102F	144 €
1200X250	EM122F	157 €
1400X250	EM142F	168 €
1500X250	EM152F	178 €
1600X250	EM162F	184 €
1800X250	EM182F	207 €
2000X250	EM202F	232 €

FONDO 400

DIMENSIONES	CÓDIGO	PRECIO
1000X400	EM104F	172 €
1200X400	EM124F	190 €
1400X400	EM144F	207 €
1500X400	EM154F	217 €
1600X400	EM164F	226 €
1800X400	EM184F	252 €
2000X400	EM204F	274 €

ESTANTES DE PARED TUBULAR

TUBULAR WALL SELF / ÉTAGÈRE MURALE TUBULAIRE



Totalmente fabricado en acero inoxidable AISI 304, 18/10. Cuatro tubos de diámetro 25 de acero inoxidable fijado a cartabones. Cartabones en acero inoxidable.

Made totally of Stainless steel AISI 304, 18/10. 40 mm straight front. Four 25 mm. diameter stainless steel tubes attached to bevels. Brackets in stainless steel.

Réalisées complètement en acier inoxydable AISI 304, 18/10. Quatre tubes de 25 mm de diamètre. en acier inoxydable.

DIMENSIONES	CÓDIGO	PRECIO
1000X400	EM104T	209 €
1200X400	EM124T	219 €
1400X400	EM144T	232 €
1500X400	EM154T	241 €
1600X400	EM164T	253 €
1800X400	EM184T	303 €
2000X400	EM204T	319 €

ESTANTES DE PARED PARA CESTAS

WALL SELF FOR BASKETS / ÉTAGÈRE MURALE POUR PANIERS

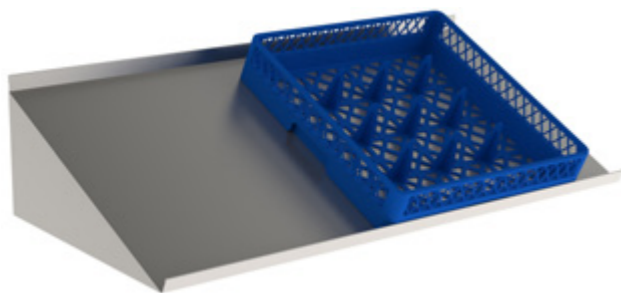

Totalmente fabricado en acero inoxidable AISI 304, 18/10.

Made totally of Stainless steel AISI 304, 18/10.

Réalisées complètement en acier inoxydable AISI 304, 18/10.

DIMENSIONES	CÓDIGO	PRECIO
700X500	EM075C	336 €
1100X500	EM115C	424 €
1600X500	EM165C	483 €

Dimensiones en mm. Los precios indicados serán gravados con el I.V.A. correspondiente.

ESTANTES MURALES PARA CAMPANAS

WALL SHELVES FOR HOODS / ÉTAGÈRES MURALES POUR HOTTES



Totalmente fabricado en acero inoxidable AISI 304, 18/10. Frente recto de 40 mm. Parrillas gastronorm 1/1 extraíbles.

Made totally of Stainless steel AISI 304, 18/10. 40 mm straight front. Removable 1/1 gastronorm grills.

Réalisées complètement en acier inoxydable AISI 304, 18/10. Front droit 40 mm. Grilles gastonormes 1/1 amovibles.

DIMENSIONES	CÓDIGO	PRECIO
1070X400X250	EM02R	347 €
1600X400X250	EM04R	404 €
2130X400X250	EM06R	452 €

ESTANTES MURALES PARA PLATOS

WALL SHELVES FOR PLATES / ÉTAGÈRES MURALES POUR ASSIETTES



Totalmente fabricado en acero inoxidable AISI 304, 18/10. Frente recto de 40 mm. Estante ranurado para alojar platos.

Made totally of Stainless steel AISI 304, 18/10. 40 mm straight front. Slotted rack for dishes.

Réalisées complètement en acier inoxydable AISI 304, 18/10. Front droit 40 mm. Rainuré rack pour la vaisselle.

DIMENSIONES	CAPACIDAD	CÓDIGO	PRECIO
1000X267	38	EM102P	323 €
1200X267	45	EM122P	375 €
1400X267	53	EM142P	427 €

ESTANTES MURALES PARA MICROONDAS

WALL SHELVES FOR MICROWAVES / ÉTAGÈRES MURALES POUR MICRO-ONDES



Totalmente fabricado en acero inoxidable AISI 304, 18/10. Frente recto de 40 mm.

Made totally of Stainless steel AISI 304, 18/10. 40 mm straight front.

Réalisées complètement en acier inoxydable AISI 304, 18/10. Front droit 40 mm.

DIMENSIONES	CÓDIGO	PRECIO
600X400	EM064M	173 €
800X400	EM084M	184 €

ESTANTES MURALES PARA CUBETAS GASTRONORM

WALL SHELVES FOR GASTRONORM BUCKETS ÉTAGÈRES MURALES POUR BACS GASTRONORM

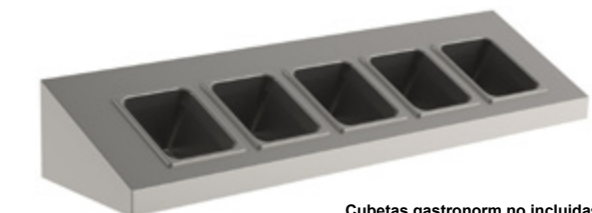

Totalmente fabricado en acero inoxidable AISI 304, 18/10. Frente recto de 40 mm.

Made totally of Stainless steel AISI 304, 18/10. 40 mm straight front.

Réalisées complètement en acier inoxydable AISI 304, 18/10. Front droit 40 mm.

Cubetas gastronorm no incluidas.
Gastronorm trays not included.
Plateaux gastronorm non inclus.

DIMENSIONES	CAPACIDAD	CÓDIGO	PRECIO
1000X250	8 GN 1/9	EM102G6	179 €
1000X250	5 GN 1/6	EM102G5	179 €
1200X250	4 GN 1/4	EM123G5	205 €

	pág.
CARROS DE SERVICIO / SERVICE TROLLEY / CHARRIOT DE SERVICE	80
CARROS DE SERVICIO Y RECOGIDA / SERVICE AND PICKUP TROLLEY / CHARRIOT DE SERVICE ET COLLECTE	80
CARROS PARA CUBETAS GASTRONORM / GASTRONORM TRAYS TROLLEY / CHARRIOT POUR BACS GASTRONORM	81
CARROS PARA BANDEJAS ISOTÉRMICAS / TROLLEYS FOR ISOTHERMAL TRAYS / CHARRIOT POUR BACS ISOTHERMIQUES	82
CARROS PARA BANDEJAS DE AUTOSERVICIO / SELF-SERVICE TRAY TROLLEYS / CHARIOTS À PLATEAUX LIBRE-SERVICE	83
CARROS PARA BANDEJAS DE PASTELERÍA / TROLLEYS FOR PASTRY TRAYS / CHARIOTS POUR PLATEAUX À PÂTISSERIE	83
CARROS PARA CESTAS DE LAVAVAJILLAS / TROLLEYS FOR DISHWASHER BASKETS / CHARIOTS POUR PANIERS LAVE-VAISSELLE	84
CARROS PARA PLATOS / TROLLEYS FOR DISHES / CHARIOTS POUR PLATS	85
CINTAS TRANSPORTADORAS DE CORDONES / CORD CONVEYOR BELTS / BANDES TRANSPORTEUSES AVEC CORDS	86
CINTAS TRANSPORTADORAS DE BANDA / CONVEYOR BELTS / BANDES TRANSPORTEUSES	87
CARRO BAÑO MARÍA / BAIN MARIE TROLEY / CHARRIOT BAIN MARIE	88
CARROS BAÑO MARÍA REFRIGERADOS / REFRIGERATED BAIN MARIE TROLEY / CHARRIOT BAIN MARIE REFROIDIE	90
CARROS CALIENTES CON HUMIDIFICACION / HOT TROLLEYS WITH HUMIDIFICATION / CHARIOTS CHAUDS AVEC HUMIDIFICATION	91



CARROS DE SERVICIO

SERVICE TROLLEY / CHARRIOT DE SERVICE



Totalmente fabricado en acero inoxidable AISI 304, 18/10. Estantes estampados e insonorizados. Soldados en todas las aristas al tubo. Tubos curvados en una sola pieza. Cuatro ruedas giratorias, dos con freno. Paragolpes de goma en las cuatro ruedas.

Made totally of Stainless steel AISI 304, 18/10. Stamped and soundproof shelves. Welded on all edges to the tube. One-piece curved tubes. Four swivel wheels, two with brakes. Rubber bumpers on all four wheels.

Réalisées complètement en acier inoxydable AISI 304, 18/10. Étagères estampées et insonorisées. Soudé sur tous les bords au tube. Tubes courbés en une seule pièce. Quatre roues pivotantes dont deux avec freins. Pare-chocs en caoutchouc sur les quatre roues.



DIMENSIONES	DIM. ESTANTE	CÓDIGO	PRECIO	CÓDIGO	PRECIO	CÓDIGO	PRECIO
900X595X975	800X500	CS085B2	438 €	CS085B3	506 €	CS085B4	663 €
1000X595X975	900X500	CS095B2	464 €	CS095B3	521 €	CS095B4	681 €
1100X595X975	1000X500	CS105B2	575 €	CS105B3	738 €	CS105B4	916 €

CARROS DE SERVICIO Y RECOGIDA

SERVICE AND PICKUP TROLLEY / CHARRIOT DE SERVICE ET COLLECTE



Totalmente fabricado en acero inoxidable AISI 304, 18/10. Estantes estampados e insonorizados. Soldados en todas las aristas al tubo. Tubos curvados en una sola pieza. Cuatro ruedas giratorias, dos con freno. Paragolpes de goma en las cuatro ruedas. Cubeta gastronorm 1/2 de 200 mm. de profundidad incluida.

Made totally of Stainless steel AISI 304, 18/10. Stamped and soundproof shelves. Welded on all edges to the tube. One-piece curved tubes. Four swivel wheels, two with brakes. Rubber bumpers on all four wheels. Gastronorm tray 1/2 of 200 mm. depth included.

Réalisées complètement en acier inoxydable AISI 304, 18/10. Étagères estampées et insonorisées. Soudé sur tous les bords au tube. Tubes courbés en une seule pièce. Quatre roues pivotantes dont deux avec freins. Pare-chocs en caoutchouc sur les quatre roues. Plateau gastronorme 1/2 de 200 mm. profondeur incluse.

DIMENSIONES	CÓDIGO	PRECIO
1100X595X975	CS105BB	708 €

Dimensiones en mm. Los precios indicados serán gravados con el I.V.A. correspondiente.

CARROS PARA CUBETAS GASTRONORM

GASTRONORM TRAYS TROLLEY / CHARRIOT POUR BACS GASTRONORM

Totalmente fabricado en acero inoxidable AISI 304, 18/10. Guías de acero inoxidable soldadas a la estructura. Tubos curvados en una sola pieza. Cuatro ruedas giratorias, dos con freno. Paragolpes de goma en las cuatro ruedas.

Made totally of Stainless steel AISI 304, 18/10. Stainless steel guides welded to the structure. One-piece curved tubes. Four swivel wheels, two with brakes. Rubber bumpers on all four wheels.

Réalisées complètement en acier inoxydable AISI 304, 18/10. Guides en acier inoxydable soudés à la structure. Tubes courbés en une seule pièce. Quatre roues pivotantes dont deux avec freins. Pare-chocs en caoutchouc sur les quatre roues.



Cubetas no incluidas

CARRO CON GUIAS SOLDADAS TROLLEY WITH WELDED GUIDES CHARIOT AVEC GUIDES SOUDÉS



DIMENSIONES	465X645X845	670X765X1595	465X645X1595	825X645X1595
CAPACIDAD	7 GN 1/1	17 GN 2/1	17 GN 1/1	34 GN 1/1
CÓDIGO	CG071	CG172	CG171	CG341
PRECIO	490 €	674 €	604 €	865 €

CARRO CON GUIAS SOLDADAS Y ENCIMERA TROLLEY WITH WELDED GUIDES AND TOP CHARIOT AVEC GUIDES SOUDÉS ET TOP



DIMENSIONES	465X645X900	670X765X1595
CAPACIDAD	8 GN 1/1	16 GN 1/1
CÓDIGO	CG081	CG161
PRECIO	448 €	506 €

CARRO CON GUIAS SOLDADAS TROLLEY WITH WELDED GUIDES CHARIOT AVEC GUIDES SOUDÉS



Cubetas no incluidas



DIMENSIONES	845X820X1035	1195X820X1035
CAPACIDAD	10 GN 1/1	15 GN 2/1
CÓDIGO	CG101	CG151
PRECIO	739 €	787 €

CARROS PARA BANDEJAS ISOTÉRMICAS

TROLLEYS FOR ISOTHERMAL TRAYS / CHARRIOT POUR BACS ISOTHERMIQUES

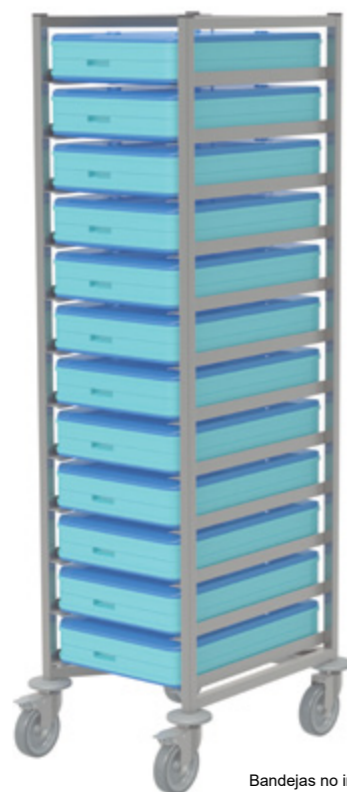

Bandejas no incluidas

Totalmente fabricado en acero inoxidable AISI 304, 18/10. Guías de acero inoxidable soldadas a la estructura. Tubos soldados. Cuatro ruedas giratorias, dos con freno. Paragolpes de goma en las cuatro ruedas.

Made totally of Stainless steel AISI 304, 18/10. Stainless steel guides welded to the structure. Welded tubes. Four swivel wheels, two with brakes. Rubber bumpers on all four wheels.

Réalisées complètement en acier inoxydable AISI 304, 18/10. Guides en acier inoxydable soudés à la structure. Tubes soudés. Quatre roues pivotantes dont deux avec freins. Pare-chocs en caoutchouc sur les quatre roues.



DIMENSIONES	515X625X1685	930X625X1685
CAPACIDAD	12	24
CÓDIGO	CI12E	CI24E
PRECIO	902 €	1.481 €

CARROS PARA BANDEJAS DE AUTOSERVICIO

SELF-SERVICE TRAY TROLLEYS / CHARIOTS À PLATEAUX LIBRE-SERVICE

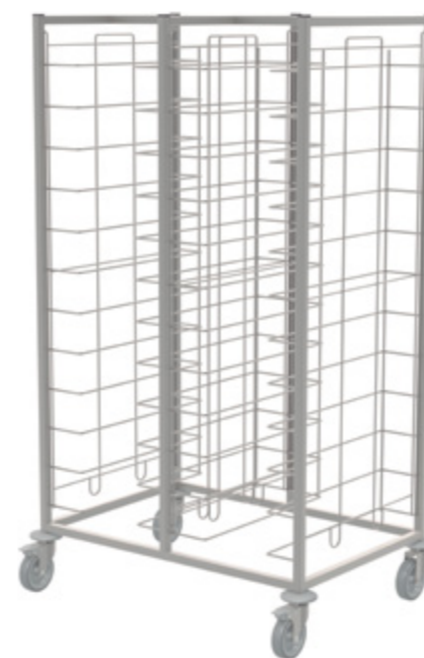

Totalmente fabricado en acero inoxidable AISI 304, 18/10. Tubos soldados. Cuatro ruedas giratorias, dos con freno. Paragolpes de goma en las cuatro ruedas.

Made totally of Stainless steel AISI 304, 18/10. Welded tubes. Four swivel wheels, two with brakes. Rubber bumpers on all four wheels.

Réalisées complètement en acier inoxydable AISI 304, 18/10. Tubes soudés. Quatre roues pivotantes dont deux avec freins. Pare-chocs en caoutchouc sur les quatre roues.



DIMENSIONES	565X725X1720	565X725X1720	1030X725X1720	1030X725X1720
CAPACIDAD	12	12	24	24
CÓDIGO	CB12A	CB12AC	CB24A	CB24AC
PRECIO	762 €	1.063 €	1.099 €	1.408 €

CARROS PARA BANDEJAS DE PASTELERÍA

TROLLEYS FOR PASTRY TRAYS / CHARIOTS POUR PLATEAUX À PÂTISSERIE

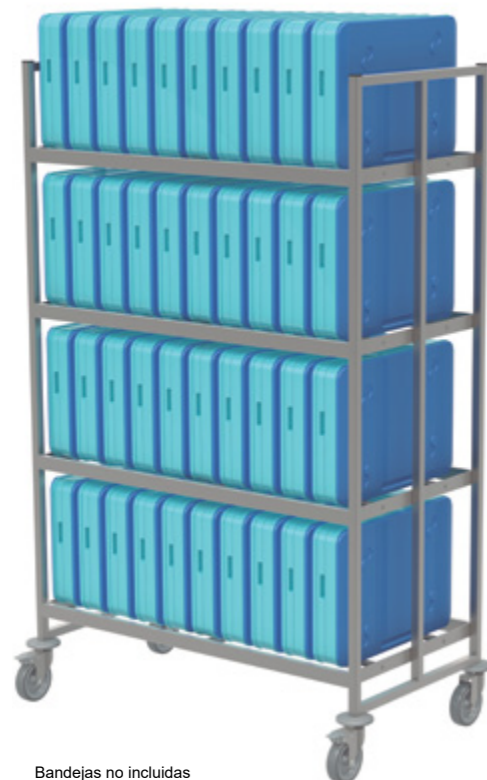

Bandejas no incluidas

Totalmente fabricado en acero inoxidable AISI 304, 18/10. Estantes soldados en todas las aristas al tubo. Tubos soldados. Cuatro ruedas giratorias, dos con freno. Paragolpes de goma en las cuatro ruedas.

Made totally of Stainless steel AISI 304, 18/10. Shelves welded on all edges to the tube. Welded tubes. Four swivel wheels, two with brakes. Rubber bumpers on all four wheels.

Réalisées complètement en acier inoxydable AISI 304, 18/10. Étagères soudés sur tous les bords au tube. Tubes soudés. Quatre roues pivotantes dont deux avec freins. Pare-chocs en caoutchouc sur les quatre roues.



DIMENSIONES	1225X675X1850
CAPACIDAD	40
CÓDIGO	CI40E
PRECIO	1.031 €



Totalmente fabricado en acero inoxidable AISI 304, 18/10. Guías de acero inoxidable soldadas a la estructura. Tubos curvados en una sola pieza. Cuatro ruedas giratorias, dos con freno. Paragolpes de goma en las cuatro ruedas.

Made totally of Stainless steel AISI 304, 18/10. Stainless steel guides welded to the structure. One-piece curved tubes. Four swivel wheels, two with brakes. Rubber bumpers on all four wheels.

Réalisées complètement en acier inoxydable AISI 304, 18/10. Guides en acier inoxydable soudés à la structure. Tubes courbés en une seule pièce. Quatre roues pivotantes dont deux avec freins. Pare-chocs en caoutchouc sur les quatre roues.



DIMENSIONES	535X695X1595
CAPACIDAD	15
CÓDIGO	CB15P
PRECIO	701 €

CARROS PARA CESTAS DE LAVAVAJILLAS

TROLLEYS FOR DISHWASHER BASKETS / CHARIOTS POUR PANIERS LAVE-VAISSELLE



Cestas no incluidas

Totalmente fabricado en acero inoxidable AISI 304, 18/10. Cuatro ruedas giratorias, dos con freno. Paragolpes de goma en las cuatro ruedas.

Made totally of Stainless steel AISI 304, 18/10. Four swivel wheels, two with brakes. Rubber bumpers on all four wheels.

Réalisées complètement en acier inoxydable AISI 304, 18/10. Quatre roues pivotantes dont deux avec freins. Pare-chocs en caoutchouc sur les quatre roues.



DIMENSIONES	515X515X185	645X700X975
CÓDIGO	CC55	CC55A
PRECIO	238 €	321 €



Cestas no incluidas

Totalmente fabricado en acero inoxidable AISI 304, 18/10. Guías de acero inoxidable soldadas a la estructura. Tubos curvados en una sola pieza. Cuatro ruedas giratorias, dos con freno. Paragolpes de goma en las cuatro ruedas.

Made totally of Stainless steel AISI 304, 18/10. Stainless steel guides welded to the structure. One-piece curved tubes. Four swivel wheels, two with brakes. Rubber bumpers on all four wheels.

Réalisées complètement en acier inoxydable AISI 304, 18/10. Guides en acier inoxydable soudés à la structure. Tubes courbés en une seule pièce. Quatre roues pivotantes dont deux avec freins. Pare-chocs en caoutchouc sur les quatre roues.



DIMENSIONES	640X655X900	640X655X1230	640X655X1570
CAPACIDAD	4	6	8
CÓDIGO	CC04B	CC06B	CC08B
PRECIO	566 €	612 €	665 €

CARROS PARA PLATOS

TROLLEYS FOR DISHES / CHARIOTS POUR PLATS



Totalmente fabricado en acero inoxidable AISI 304, 18/10. Separadores regulables según el tamaño del plato. Cuatro ruedas giratorias, dos con freno. Paragolpes de goma en las cuatro ruedas.

Completely made of AISI 304, 18/10 stainless steel. Adjustable spacers according to the size of the plate. Four swivel wheels, two with brakes. Rubber bumpers on all four wheels.

Entièrement en acier inoxydable AISI 304, 18/10. Entretoises réglables selon la taille de la plaque. Quatre roues pivotantes dont deux avec freins. Pare-chocs en caoutchouc sur les quatre roues.



DIMENSIONES	475X880X830	845X880X830
CAPACIDAD	150	300
CÓDIGO	CP150	CP300
PRECIO	853 €	1.016 €



Totalmente fabricado en acero inoxidable AISI 304, 18/10. Regulable según el tamaño del plato. Superficie de apoyo de los platos con topes anti-caída. Estructura fabricada en tubo de sección cuadrada mediante soldadura. Cuatro ruedas giratorias, dos con freno. Paragolpes de goma en las cuatro ruedas.

Completely made of AISI 304, 18/10 stainless steel. Adjustable according to the size of the plate. Support surface of the plates with anti-fall stops. Structure made of square section tube by welding. Four swivel wheels, two with brakes. Rubber bumpers on all four wheels.

Entièrement en acier inoxydable AISI 304, 18/10. Réglable selon la taille de l'assiette. Surface d'appui des plaques avec butées anti-chute. Structure en tube de section carrée par soudure. Quatre roues pivotantes dont deux avec freins. Pare-chocs en caoutchouc sur les quatre roues.



DIMENSIONES	629X714X1750
CAPACIDAD	100
CÓDIGO	CP100R
PRECIO	1.174 €

CINTAS TRANSPORTADORAS DE CORDONES

CORD CONVEYOR BELTS / BANDES TRANSPORTEUSES AVEC CORDS



CINTAS TRANSPORTADORAS DE BANDA

CONVEYOR BELTS / BANDES TRANSPORTEUSES

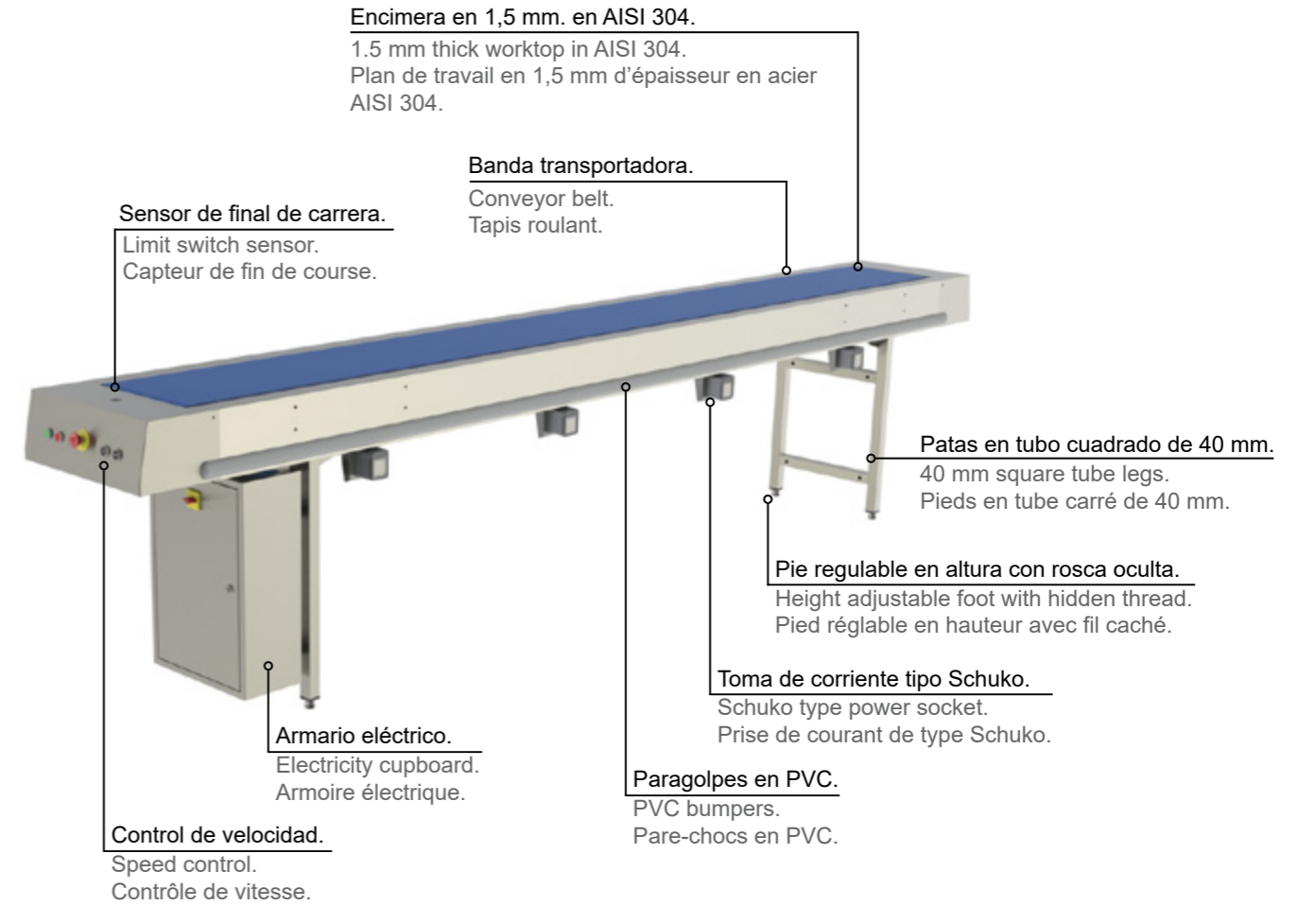

DIMENSIONES	POTENCIA	VELOCIDAD	Nº ENCHUFES	CÓDIGO	PRECIO
2000x500x900	120 W	0,36 m/s	4	CTC205	8.826 €
2500x500x900	120 W	0,36 m/s	4	CTC255	9.025 €
3000x500x900	120 W	0,36 m/s	6	CTC305	9.120 €
3500x500x900	120 W	0,36 m/s	6	CTC355	9.252 €
4000x500x900	120 W	0,36 m/s	8	CTC405	9.467 €
4500x500x900	120 W	0,36 m/s	8	CTC455	9.910 €
5000x500x900	120 W	0,36 m/s	10	CTC505	10.094 €
5500x500x900	120 W	0,36 m/s	10	CTC555	10.255 €
6000x500x900	120 W	0,36 m/s	12	CTC605	10.515 €
6500x500x900	120 W	0,36 m/s	12	CTC655	10.864 €
7000x500x900	120 W	0,36 m/s	14	CTC705	11.106 €
7500x500x900	120 W	0,36 m/s	14	CTC755	11.300 €
8000x500x900	120 W	0,36 m/s	16	CTC805	11.635 €
8500x500x900	120 W	0,36 m/s	16	CTC855	11.956 €
9000x500x900	120 W	0,36 m/s	18	CTC905	12.200 €

DIMENSIONES	POTENCIA	VELOCIDAD	Nº ENCHUFES	CÓDIGO	PRECIO
2000x500x900	120 W	0,36 m/s	4	CTB205	9.519 €
2500x500x900	120 W	0,36 m/s	4	CTB255	9.731 €
3000x500x900	120 W	0,36 m/s	6	CTB305	9.814 €
3500x500x900	120 W	0,36 m/s	6	CTB355	9.907 €
4000x500x900	120 W	0,36 m/s	8	CTB405	10.084 €
4500x500x900	120 W	0,36 m/s	8	CTB455	10.586 €
5000x500x900	120 W	0,36 m/s	10	CTB505	10.692 €
5500x500x900	120 W	0,36 m/s	10	CTB555	10.920 €
6000x500x900	120 W	0,36 m/s	12	CTB605	11.231 €
6500x500x900	120 W	0,36 m/s	12	CTB655	11.381 €
7000x500x900	120 W	0,36 m/s	14	CTB705	11.585 €
7500x500x900	120 W	0,36 m/s	14	CTB755	12.076 €
8000x500x900	120 W	0,36 m/s	16	CTB805	12.353 €
8500x500x900	120 W	0,36 m/s	16	CTB855	12.497 €
9000x500x900	120 W	0,36 m/s	18	CTB905	12.559 €

CARRO BAÑO MARÍA ABIERTO

OPEN BAIN MARIE TROLLEY / CHARRIOT OUVERT BAIN MARIE



Totalmente fabricado en acero inoxidable AISI 304, 18/10. Encimera con cuba soldada. Cuba con radios redondeados para facilitar la limpieza. Sistema de vaciado manual situado en el exterior, fácilmente accesible. Calentamiento mediante resistencias de silicona adheridas a la cuba. Tirador de acero inoxidable. Control de temperatura mediante termostato digital. Manguera de alimentación extensible a tres metros y dotada de clavija tipo schuko. Interruptor de encendido con indicador luminoso. Bastidor inferior en tubo de acero inoxidable. Estante inferior reforzado y unido a patas. Cuatro ruedas giratorias, dos de ellas dotadas de freno. Paragolpes de goma angular en todas las esquinas.

Completely made of AISI 304, 18/10 stainless steel. Worktop with welded tank. Bowl with rounded radii to facilitate cleaning. Manual emptying system located outside, easily accessible. Heating by means of silicone resistances adhered to the tank. Stainless steel handle. Temperature control by digital thermostat. Power hose extendable to three meters and equipped with a Schuko plug. Power switch with indicator light. Lower frame in stainless steel tube. Reinforced lower shelf attached to legs. Four swivel wheels, two of them equipped with brakes. Angled rubber bumpers on all corners.

Entièrement en acier inoxydable AISI 304, 18/10. Plan de travail avec cuve soudée. Bol à rayons arrondis pour faciliter le nettoyage. Système de vidange manuel situé à l'extérieur, facilement accessible. Chauffage au moyen de résistances en silicone collées à la cuve. Poignée en acier inoxydable. Contrôle de la température par thermostat numérique. Tuyau d'alimentation extensible à trois mètres et équipé d'une prise Schuko. Interrupteur d'alimentation avec voyant lumineux. Cadre inférieur en tube d'acier inoxydable. Tablette inférieure renforcée fixée aux pieds. Quatre roues pivotantes dont deux équipées de freins. Pare-chocs en caoutchouc angulaires à tous les coins.



DIMENSIONES	860x690X900	1260x690X900	860x690X900	1260x690X900
CAPACIDAD	2 GN 1/1	3 GN 1/1	2 GN 1/1	3 GN 1/1
POTENCIA	1 Kw - 230 V	2 Kw - 230 V	2 Kw - 230 V	3 Kw - 230 V
CÓDIGO	C121BM	C131BM	C211BM	C311BM
PRECIO	1.742 €	2.037 €	2.153 €	2.570 €

CARROS BAÑO MARIA CON RESERVA

BAIN MARIE TROLLEY WIYH RESERVE/ CHARRIOT BAIN MARIE AVEC RÉSERVE



Totalmente fabricado en acero inoxidable AISI 304, 18/10. Encimera con cuba soldada. Cuba con radios redondeados para facilitar la limpieza. Sistema de vaciado manual situado en el exterior, fácilmente accesible. Calentamiento mediante resistencias de silicona adheridas a la cuba. Tirador de acero inoxidable. Control de temperatura mediante termostato digital. Manguera de alimentación extensible a tres metros y dotada de clavija tipo schuko. Interruptor de encendido con indicador luminoso. Armario inferior con calentamiento mediante resistencias acorazadas. Dotado de guías para bandejas gastronorm 1/1. Aislado mediante paneles de poliuretano. Puertas con perfil de silicona y cierre con maneta. Cuatro ruedas giratorias, dos de ellas dotadas de freno. Paragolpes de goma angular en todas las esquinas.

Completely made of AISI 304, 18/10 stainless steel. Worktop with welded tank. Bowl with rounded radii to facilitate cleaning. Manual emptying system located outside, easily accessible. Heating by means of silicone resistances adhered to the tank. Stainless steel handle. Temperature control by digital thermostat. Power hose extendable to three meters and equipped with a Schuko plug. Power switch with indicator light. Lower cabinet heated by armored resistors. Provided with guides for 1/1 gastronorm trays. Insulated by polyurethane panels. Doors with silicone profile and handle closing. Four swivel wheels, two of them equipped with brakes. Angled rubber bumpers on all corners.

Entièrement en acier inoxydable AISI 304, 18/10. Plan de travail avec cuve soudée. Bol à rayons arrondis pour faciliter le nettoyage. Système de vidange manuel situé à l'extérieur, facilement accessible. Chauffage au moyen de résistances en silicone collées à la cuve. Poignée en acier inoxydable. Contrôle de la température par thermostat numérique. Tuyau d'alimentation extensible à trois mètres et équipé d'une prise Schuko. Interrupteur d'alimentation avec voyant lumineux. Armoire inférieure avec résistances blindées. Muni de guides pour plateaux gastronorme 1/1. Isolation par panneaux en polyuréthane. Portes avec profil en silicone et fermeture par poignée. Quatre roues pivotantes, dont deux équipées de freins. Pare-chocs en caoutchouc angulaires à tous les coins.



DIMENSIONES	860x690X900	1260x690X900	860x690X900	1260x690X900
CAPACIDAD	2 GN 1/1	3 GN 1/1	2 GN 1/1	3 GN 1/1
POTENCIA	1,75 Kw - 230 V	3,5 Kw - 230 V	2,75 Kw - 230 V	4,5 Kw - 230 V
CÓDIGO	C121BMR	C131BMR	C211BMR	C311BMR
PRECIO	2.560 €	2.875 €	2.898 €	3.481 €

CARROS BAÑO MARÍA REFRIGERADOS

REFRIGERATED BAIN MARIE TROLLEY / CHARRIOT BAIN MARIE REFROIDIE



Totalmente fabricado en acero inoxidable AISI 304, 18/10. Encimera con cuba soldada. Cuba con radios redondeados para facilitar la limpieza. Aislado mediante poliuretano de alta densidad. Refrigeración mediante serpentín adherido a la parte inferior. Unidad hermética con refrigerante R134A o R290. Tirador de acero inoxidable. Control de temperatura mediante termostato digital. Manguera de alimentación extensible a tres metros y dotada de clavija tipo schuko. Interruptor de encendido con indicador luminoso. Bastidor inferior en tubo de acero inoxidable. Estante inferior reforzado y unido a patas. Cuatro ruedas giratorias, dos de ellas dotadas de freno. Paragolpes de goma angular en todas las esquinas.

Completely made of AISI 304, 18/10 stainless steel. Worktop with welded tank. Bowl with rounded radii to facilitate cleaning. Insulated by high-density polyurethane. Cooling by means of a coil attached to the bottom. Hermetic unit with R134A or R290 refrigerant. Stainless steel handle. Temperature control by digital thermostat. Power hose extendable to three meters and equipped with a Schuko plug. Power switch with indicator light. Lower frame in stainless steel tube. Reinforced lower shelf attached to legs. Four swivel wheels, two of them equipped with brakes. Angled rubber bumpers on all corners.

Entièrement en acier inoxydable AISI 304, 18/10. Plan de travail avec cuve soudée. Bol à rayons arrondis pour faciliter le nettoyage. Isolation en polyuréthane haute densité. Refroidissement au moyen d'un serpentín fixé au fond. Unité hermétique avec réfrigérant R134A ou R290. Poignée en acier inoxydable. Contrôle de la température par thermostat numérique. Tuyau d'alimentation extensible à trois mètres et équipé d'une prise Schuko. Interrupteur d'alimentation avec voyant lumineux. Cadre inférieur en tube d'acier inoxydable. Tablette inférieure renforcée fixée aux pieds. Quatre roues pivotantes dont deux équipées de freins. Pare-chocs en caoutchouc angulaires à tous les coins.



DIMENSIONES	860x690X900	1260x690X900
CAPACIDAD	2 GN 1/1	3 GN 1/1
POTENCIA	0,75 Kw - 230 V	0,75 Kw - 230 V
CÓDIGO	C121BMF	C131BMF
PRECIO	2.226 €	2.621 €

A-CERINOX

CARROS CALIENTES CON HUMIDIFICACION

HOT TROLLEYS WITH HUMIDIFICATION / CHARIOTS CHAUDS AVEC HUMIDIFICATION



Totalmente fabricado en acero inoxidable AISI 304, 18/10. Construcción mediante paneles de acero inoxidable con aislamiento en poliuretano. Cuerpo de guías con capacidad para bandejas gastronorm 2/1 (10, 20 o 40 según modelo) fabricado en acero inoxidable y fácilmente extraíble. Tirador exterior de acero inoxidable. Puerta abatible con guarnición de silicona, aislada mediante panel de poliuretano y con manilla de bloqueo. Cajón inferior eléctrico totalmente extraíble. Resistencia acorazada y ventilada para el calentamiento uniforme del carro. Recipiente para el sistema de humidificación incluida y dotada de rompeolas para evitar el derrame durante el uso del carro. Control de la temperatura mediante termostato digital, con interruptor de encendido y manguera de alimentación extraíble con una longitud de tres metros. Paragolpes de goma angular. Cuatro ruedas giratorias en la parte inferior, dos de ellas dotadas de freno.

Completely made of AISI 304, 18/10 stainless steel. Construction using stainless steel panels with polyurethane insulation. Guide body with capacity for 2/1 gastronorm trays (10, 20 or 40 depending on the model) made of stainless steel and easily removable. External stainless steel handle. Swing door with silicone trim, insulated by polyurethane panel and with locking handle. Fully removable electric lower drawer. Armored and ventilated resistance for uniform heating of the trolley. Container for the humidification system included and equipped with breakwaters to prevent spillage during use of the cart. Temperature control by digital thermostat, with power switch and removable power hose with a length of three meters. Angular rubber bumpers. Four swivel wheels at the bottom, two of them equipped with brakes.

Entièrement en acier inoxydable AISI 304, 18/10. Construction en panneaux d'acier inoxydable avec isolation en polyuréthane. Corps de guidage d'une capacité de 2/1 plateaux gastronorm (10, 20 ou 40 selon le modèle) en acier inoxydable et facilement démontable. Poignée extérieure en acier inoxydable. Porte battante avec garniture en silicone, isolée par panneau en polyuréthane et avec poignée de verrouillage. Tiroir inférieur électrique entièrement amovible. Résistance blindée et ventilée pour un chauffage uniforme du chariot. Conteneur pour le système d'humidification inclus et équipé de brise-lames pour éviter les déversements lors de l'utilisation du chariot. Contrôle de la température par thermostat numérique, avec interrupteur d'alimentation et tuyau d'alimentation amovible d'une longueur de trois mètres. Pare-chocs angulaires en caoutchouc. Quatre roues pivotantes en bas, dont deux équipées de freins.



DIMENSIONES	710X865X1150	710X865X1805	1400X865X1805
CAPACIDAD	10 GN 2/1	20 GN 2/1	40 GN 2/1
POTENCIA	2 Kw - 230 V	2 Kw - 230 V	2 Kw - 230 V
CÓDIGO	CB10CH	CB20CH	CB40CH
PRECIO	3.017 €	3.608 €	5.687 €

CARROS

A-CERINOX



Campanas y extracción.

Hoods and extraction. / Hottes et extraction.

	pág.
CAMPANA MURAL / WALL HOOD / HOTTE MURALE	94
CAMPANA CENTRAL / CENTRAL HOOD / HOTTE CENTRALE	95
CAMPANA CON APORTACIÓN DE AIRE / HOOD WITH AIR SUPPLY / HOTTE AVEC COMPENSATION D'AIR	96
CAMPANA MURAL PARA HORNOS / WALL HOOD FOR OVENS / HOTTE MURALE POUR FOURS	97
CAMPANA CENTRAL PARA HORNOS / CENTRAL HOOD FOR OVENS / HOTTE CENTRALE POUR FOURS	97
CAMPANA SIN FILTROS PARA VAPOR / HOOD WITHOUT FILTERS FOR STEAM / HOTTE SANS FILTRES POUR VAPEUR	98
PLENUM PARA CAMPANA / PLENUM FOR HOOD / PLENUM POUR HOTTE	98
KIT DE ILUMINACIÓN PARA CAMPANA / LIGHTING KIT FOR HOOD / KIT D'ÉCLAIRAGE POUR HOTTE	99
FILTROS PARA CAMPANAS / FILTERS FOR HOODS / FILTRES POUR HOTTES	99



CAMPANA MURAL

WALL HOOD / HOTTE MURALE



Totalmente fabricado en acero inoxidable AISI 304, 18/10. Totalmente construída mediante soldadura. Canal perimétrico de recogida de condensados y grasas. Colector posterior dotado de tubo de descarga con tapón. Dotada de filtros de acero inoxidable tipo laberinto.

Completely made of AISI 304, 18/10 stainless steel. Completely built by welding. Perimetric channel for collecting condensates and fats. Rear collector equipped with a discharge tube with a cap. Equipped with labyrinth-type stainless steel filters.

Entièrement en acier inoxydable AISI 304, 18/10. Entièrement construit par soudure. Canal périmétrique pour la collecte des condensats et des graisses. Collecteur arrière équipé d'un tube d'évacuation avec bouchon. Équipé de filtres en acier inoxydable de type labyrinthe.

Recta / Straight / Droite

LONGITUD	Nº DE FILTROS	FONDO 750		FONDO 1000		FONDO 1200	
		CÓDIGO	PRECIO	CÓDIGO	PRECIO	CÓDIGO	PRECIO
1000	2	V1007FR	913 €	V1010FR	958 €	V1012FR	1.001 €
1500	3	V1507FR	1.313 €	V1510FR	1.356 €	V1512FR	1.400 €
2000	4	V2007FR	1.475 €	V2010FR	1.563 €	V2012FR	1.651 €
2500	5	V2507FR	1.843 €	V2510FR	1.916 €	V2512FR	1.990 €
3000	6	V3007FR	2.063 €	V3010FR	2.136 €	V3012FR	2.211 €
3500	7	V3507FR	2.539 €	V3510FR	2.629 €	V3512FR	2.718 €
4000	8	V4007FR	2.768 €	V4010FR	2.922 €	V4012FR	3.077 €

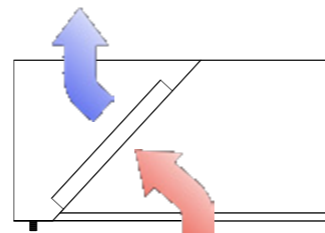

Inclinada superior / Inclined top / Haut incliné

LONGITUD	Nº DE FILTROS	FONDO 750		FONDO 1000		FONDO 1200	
		CÓDIGO	PRECIO	CÓDIGO	PRECIO	CÓDIGO	PRECIO
1000	2	V1007IS	1.007 €	V1010IS	1.033 €	V1012IS	1.058 €
1500	3	V1507IS	1.330 €	V1510IS	1.443 €	V1512IS	1.555 €
2000	4	V2007IS	1.492 €	V2010IS	1.567 €	V2012IS	1.642 €
2500	5	V2507IS	1.678 €	V2510IS	1.877 €	V2512IS	2.077 €
3000	6	V3007IS	1.977 €	V3010IS	2.102 €	V3012IS	2.226 €
3500	7	V3507IS	2.672 €	V3510IS	2.710 €	V3512IS	1.595 €
4000	8	V4007IS	2.835 €	V4010IS	2.872 €	V4012IS	2.910 €

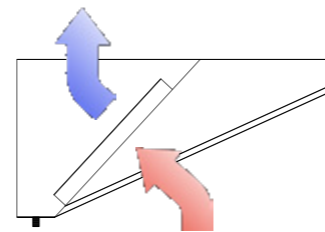

Inclinada / Inclined / Incliné

LONGITUD	Nº DE FILTROS	FONDO 750		FONDO 1000		FONDO 1200	
		CÓDIGO	PRECIO	CÓDIGO	PRECIO	CÓDIGO	PRECIO
1000	2	V1007II	1.038 €	V1010II	1.064 €	V1012II	1.407 €
1500	3	V1507II	1.371 €	V1510II	1.488 €	V1512II	1.920 €
2000	4	V2007II	1.538 €	V2010II	1.616 €	V2012II	2.010 €
2500	5	V2507II	1.730 €	V2510II	1.935 €	V2512II	2.458 €
3000	6	V3007II	2.039 €	V3010II	2.166 €	V3012II	2.929 €
3500	7	V3507II	2.755 €	V3510II	2.794 €	V3512II	3.467 €
4000	8	V4007II	2.922 €	V4010II	2.960 €	V4012II	3.635 €

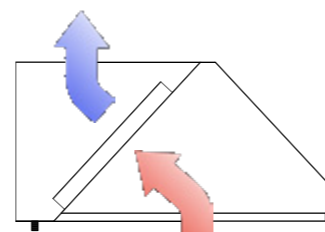

Doble inclinación / Double tilt / Double inclinaison

LONGITUD	Nº DE FILTROS	FONDO 750		FONDO 1000		FONDO 1200	
		CÓDIGO	PRECIO	CÓDIGO	PRECIO	CÓDIGO	PRECIO
1000	2	V1007DI	1.038 €	V1010DI	1.083 €	V1012DI	1.445 €
1500	3	V1507DI	1.465 €	V1510DI	1.565 €	V1512DI	1.981 €
2000	4	V2007DI	1.371 €	V2010DI	1.666 €	V2012DI	2.278 €
2500	5	V2507DI	1.824 €	V2510DI	2.025 €	V2512DI	2.542 €
3000	6	V3007DI	2.109 €	V3010DI	2.230 €	V3012DI	2.987 €
3500	7	V3507DI	2.821 €	V3510DI	2.884 €	V3512DI	3.583 €
4000	8	V4007DI	3.025 €	V4010DI	3.077 €	V4012DI	3.762 €

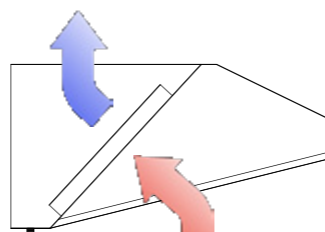

CAMPANA CENTRAL

CENTRAL HOOD / HOTTE CENTRALE

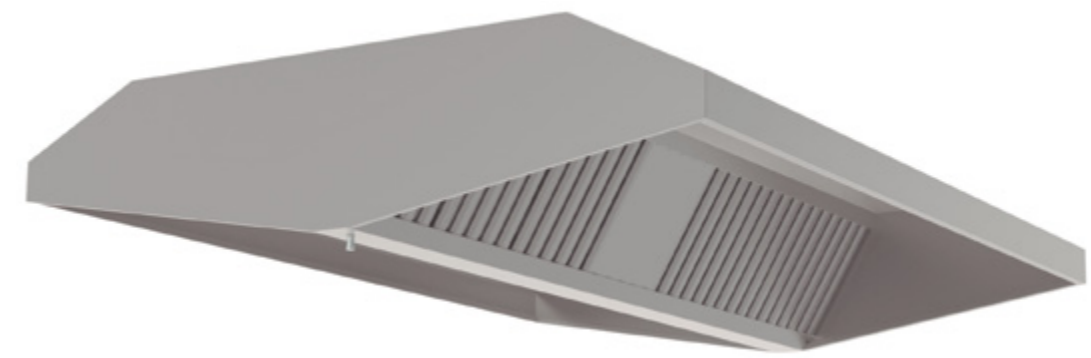

Totalmente fabricado en acero inoxidable AISI 304, 18/10. Totalmente construída mediante soldadura. Canal perimétrico de recogida de condensados y grasas. Colector posterior dotado de tubo de descarga con tapón. Dotada de filtros de acero inoxidable tipo laberinto.

Completely made of AISI 304, 18/10 stainless steel. Completely built by welding. Perimetric channel for collecting condensates and fats. Rear collector equipped with a discharge tube with a cap. Equipped with labyrinth-type stainless steel filters.

Entièrement en acier inoxydable AISI 304, 18/10. Entièrement construit par soudure. Canal périmétrique pour la collecte des condensats et des graisses. Collecteur arrière équipé d'un tube d'évacuation avec bouchon. Équipé de filtres en acier inoxydable de type labyrinthe.

Recta / Straight / Droite

LONGITUD	Nº DE FILTROS	FONDO 1500		FONDO 1800		FONDO 2200	
		CÓDIGO	PRECIO	CÓDIGO	PRECIO	CÓDIGO	PRECIO
1000	2	V1015FR	1.416 €	V1018FR	1.666 €	V1022FR	2.000 €
1500	3	V1515FR	1.790 €	V1518FR	2.116 €	V1522FR	2.551 €
2000	4	V2015FR	2.453 €	V2018FR	2.665 €	V2022FR	2.949 €
2500	5	V2515FR	2.108 €	V2518FR	3.154 €	V2522FR	3.410 €
3000	6	V3015FR	3.238 €	V3018FR	3.449 €	V3022FR	3.730 €
3500	7	V3515FR	3.802 €	V3518FR	3.973 €	V3522FR	4.204 €
4000	8	V4015FR	4.324 €	V4018FR	4.486 €	V4022FR	4.704 €

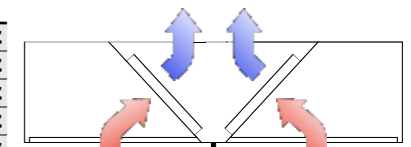

Inclinada superior / Inclined top / Haut incliné

LONGITUD	Nº DE FILTROS	FONDO 1500		FONDO 1800		FONDO 2200	
		CÓDIGO	PRECIO	CÓDIGO	PRECIO	CÓDIGO	PRECIO
1000	2	V1015IS	1.180 €	V1018IS	1.437 €	V1022IS	1.778 €
1500	3	V1515IS	1.638 €	V1518IS	1.889 €	V1522IS	2.223 €
2000	4	V2015IS	2.284 €	V2018IS	2.466 €	V2022IS	2.710 €
2500	5	V2515IS	2.181 €	V2518IS	2.831 €	V2522IS	3.130 €
3000	6	V3015IS	2.978 €	V3018IS	3.160 €	V3022IS	3.404 €
3500	7	V3515IS	3.330 €	V3518IS	3.568 €	V3522IS	3.885 €
4000	8	V4015IS	3.647 €	V4018IS	3.885 €	V4022IS	4.202 €

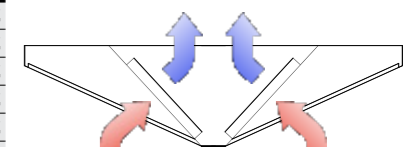

Inclinada / Inclined / Incliné

LONGITUD	Nº DE FILTROS	FONDO 1500		FONDO 1800		FONDO 2200	
		CÓDIGO	PRECIO	CÓDIGO	PRECIO	CÓDIGO	PRECIO
1000	2	V1015II	1.242 €	V1018II	1.512 €	V1022II	1.871 €
1500	3	V1515II	1.724 €	V1518II	1.988 €	V1522II	2.339 €
2000	4	V2015II	2.404 €	V2018II	2.596 €	V2022II	2.852 €
2500	5	V2515II	2.297 €	V2518II	2.981 €	V2522II	3.295 €
3000	6	V3015II	3.134 €	V3018II	3.327 €	V3022II	3.583 €
3500	7	V3515II	3.505 €	V3518II	3.756 €	V3522II	4.090 €
4000	8	V4015II	3.840 €	V4018II	4.090 €	V4022II	4.423 €

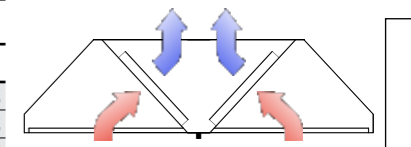

Doble inclinación / Double tilt / Double inclinaison

LONGITUD	Nº DE FILTROS	FONDO 1500		FONDO 1800		FONDO 2200	
		CÓDIGO	PRECIO	CÓDIGO	PRECIO	CÓDIGO	PRECIO
1000	2	V1015DI	1.180 €	V1018DI	1.526 €	V1022DI	1.889 €
1500	3	V1515DI	1.638 €	V1518DI	2.006 €	V1522DI	2.361 €
2000	4	V2015DI	2.284 €	V2018DI	2.620 €	V2022DI	2.879 €
2500	5	V2515DI	2.181 €	V2518DI	3.009 €	V2522DI	3.325 €
3000	6	V3015DI	2.978 €	V3018DI	3.358 €	V3022DI	3.616 €
3500	7	V3515DI	3.330 €	V3518DI	3.791 €	V3522DI	4.128 €
4000	8	V4015DI	3.647 €	V4018DI	4.128 €	V4022DI	4.464 €

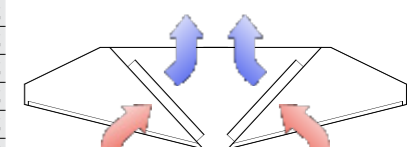

CAMPANA CON APORTACIÓN DE AIRE

HOOD WITH AIR SUPPLY / HOTTE AVEC COMPENSATION D'AIR



Totalmente fabricado en acero inoxidable AISI 304, 18/10. Totalmente construída mediante soldadura. Canal perimétrico de recogida de condensados y grasas. Colector posterior dotado de tubo de descarga con tapón. Dotada de filtros de acero inoxidable tipo laberinto.

Completely made of AISI 304, 18/10 stainless steel. Completely built by welding. Perimetric channel for collecting condensates and fats. Rear collector equipped with a discharge tube with a cap. Equipped with labyrinth-type stainless steel filters.

Entièrement en acier inoxydable AISI 304, 18/10. Entièrement construit par soudure. Canal périmétrique pour la collecte des condensats et des graisses. Collecteur arrière équipé d'un tube d'évacuation avec bouchon. Équipé de filtres en acier inoxydable de type labyrinthe.

CAMPANA MURAL / WALL HOOD / HOTTE MURALE

Aportación de aire exterior

LONGITUD	Nº DE FILTROS	FONDO 1000		FONDO 1200	
		CÓDIGO	PRECIO	CÓDIGO	PRECIO
1000	2	V1010AE	1.239 €	V1012AE	1.284 €
1500	3	V1510AE	1.779 €	V1512AE	1.823 €
2000	4	V2010AE	2.003 €	V2012AE	2.092 €
2500	5	V2510AE	2.442 €	V2512AE	2.514 €
3000	6	V3010AE	2.915 €	V3012AE	3.336 €
3500	7	V3510AE	3.747 €	V3512AE	3.837 €
4000	8	V4010AE	4.131 €	V4012AE	4.284 €

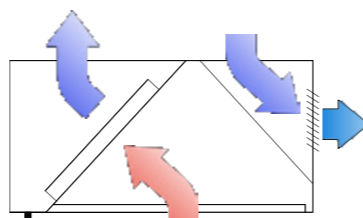

Aportación de aire interior

LONGITUD	Nº DE FILTROS	FONDO 1000		FONDO 1200	
		CÓDIGO	PRECIO	CÓDIGO	PRECIO
1000	2	V1010AI	1.135 €	V1012AI	1.180 €
1500	3	V1510AI	1.572 €	V1512AI	1.616 €
2000	4	V2010AI	1.795 €	V2012AI	1.884 €
2500	5	V2510AI	2.234 €	V2512AI	2.307 €
3000	6	V3010AI	2.604 €	V3012AI	2.679 €
3500	7	V3510AI	3.436 €	V3512AI	3.526 €
4000	8	V4010AI	3.820 €	V4012AI	3.973 €

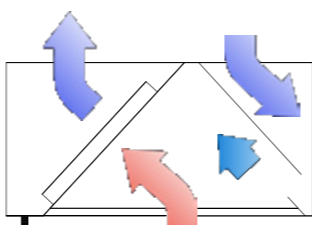

CAMPANA CENTRAL/ CENTRAL HOOD / HOTTE CENTRALE

Aportación de aire exterior

LONGITUD	Nº DE FILTROS	FONDO 1800		FONDO 2200	
		CÓDIGO	PRECIO	CÓDIGO	PRECIO
1000	2	V1018AE	2.021 €	V1022AE	2.354 €
1500	3	V1518AE	2.736 €	V1522AE	3.171 €
2000	4	V2018AE	3.325 €	V2022AE	3.607 €
2500	5	V2518AE	3.382 €	V2522AE	4.127 €
3000	6	V3018AE	4.411 €	V3022AE	4.692 €
3500	7	V3518AE	4.994 €	V3522AE	5.225 €
4000	8	V4018AE	5.544 €	V4022AE	5.762 €

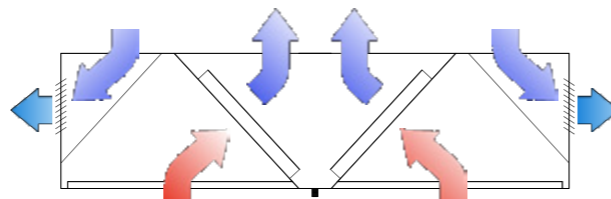

Aportación de aire interior

LONGITUD	Nº DE FILTROS	FONDO 1800		FONDO 2200	
		CÓDIGO	PRECIO	CÓDIGO	PRECIO
1000	2	V1018AI	1.814 €	V1022AI	2.147 €
1500	3	V1518AI	2.321 €	V1522AI	2.756 €
2000	4	V2018AI	2.910 €	V2022AI	3.192 €
2500	5	V2518AI	2.967 €	V2522AI	3.712 €
3000	6	V3018AI	3.789 €	V3022AI	2.918 €
3500	7	V3518AI	4.372 €	V3522AI	4.603 €
4000	8	V4018AI	4.922 €	V4022AI	5.140 €

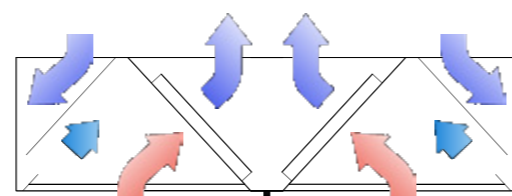

CAMPANA MURAL PARA HORNOS

WALL HOOD FOR OVENS / HOTTE MURALE POUR FOURS

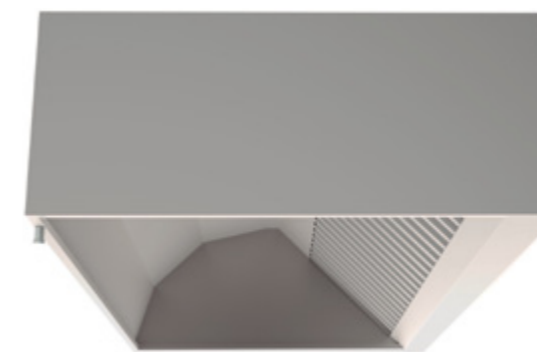

Totalmente fabricado en acero inoxidable AISI 304, 18/10. Totalmente construída mediante soldadura. Canal perimétrico de recogida de condensados y grasas. Colector posterior dotado de tubo de descarga con tapón. Dotada de filtros de acero inoxidable tipo laberinto.

Completely made of AISI 304, 18/10 stainless steel. Completely built by welding. Perimetric channel for collecting condensates and fats. Rear collector equipped with a discharge tube with a cap. Equipped with labyrinth-type stainless steel filters.

Entièrement en acier inoxydable AISI 304, 18/10. Entièrement construit par soudure. Canal périmétrique pour la collecte des condensats et des graisses. Collecteur arrière équipé d'un tube d'évacuation avec bouchon. Équipé de filtres en acier inoxydable de type labyrinthe.

LONGITUD	Nº DE FILTROS	FONDO 1200		FONDO 1400	
		CÓDIGO	PRECIO	CÓDIGO	PRECIO
1000	2	V1012IH	1.449 €	V1014IH	1.538 €
1500	3	V1512IH	1.794 €	V1514IH	1.929 €
2000	4	V2012IH	2.141 €	V2014IH	2.260 €
2500	5	V2512IH	2.423 €	V2514IH	2.487 €
3000	6	V3012IH	2.564 €	V3014IH	2.805 €
3500	7	V3512IH	3.077 €	V3514IH	3.243 €
4000	8	V4012IH	3.320 €	V4014IH	3.512 €

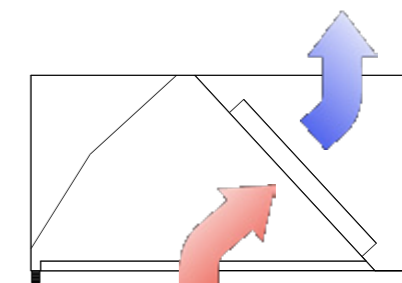

CAMPANA CENTRAL PARA HORNOS

CENTRAL HOOD FOR OVENS / HOTTE CENTRALE POUR FOURS



Totalmente fabricado en acero inoxidable AISI 304, 18/10. Totalmente construída mediante soldadura. Canal perimétrico de recogida de condensados y grasas. Colector posterior dotado de tubo de descarga con tapón. Dotada de filtros de acero inoxidable tipo laberinto.

Completely made of AISI 304, 18/10 stainless steel. Completely built by welding. Perimetric channel for collecting condensates and fats. Rear collector equipped with a discharge tube with a cap. Equipped with labyrinth-type stainless steel filters.

Entièrement en acier inoxydable AISI 304, 18/10. Entièrement construit par soudure. Canal périmétrique pour la collecte des condensats et des graisses. Collecteur arrière équipé d'un tube d'évacuation avec bouchon. Équipé de filtres en acier inoxydable de type labyrinthe.

LONGITUD	Nº DE FILTROS	FONDO 1800		FONDO 2200	
		CÓDIGO	PRECIO	CÓDIGO	PRECIO
1000	2	V1018IH	1.783 €	V1022IH	2.140 €
1500	3	V1518IH	2.264 €	V1522IH	2.730 €
2000	4	V2018IH	2.852 €	V2022IH	3.155 €
2500	5	V2518IH	3.313 €	V2522IH	3.648 €
3000	6	V3018IH	3.690 €	V3022IH	3.991 €
3500	7	V3518IH	4.252 €	V3522IH	4.499 €
4000	8	V4018IH	4.801 €	V4022IH	5.034 €

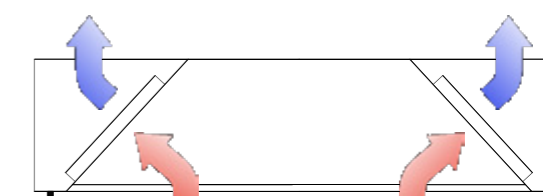

CAMPANA SIN FILTROS PARA VAPOR HOOD WITHOUT FILTERS FOR STEAM / HOTTE SANS FILTRES POUR VAPEUR



Totalmente fabricado en acero inoxidable AISI 304, 18/10. Totalmente construida mediante soldadura. Canal perimétrico de recogida de condensados. Colector dotado de tubo de descarga con tapón. Concebida para favorecer la extracción de vapores en la zona de lavado de vajilla. Sistema de extracción sin filtros.

Completely made of AISI 304, 18/10 stainless steel. Completely built by welding. Perimeter condensate collection channel. Manifold equipped with a discharge tube with a stopper. Conceived to favor the extraction of vapors in the dishwashing area. Extraction system without filters.

Entièrement en acier inoxydable AISI 304, 18/10. Entièrement construit par soudure. Canal périmétrique de collecte des condensats. Collecteur équipé d'un tube à décharge avec un bouchon. Conçu pour favoriser l'extraction des vapeurs dans la zone de lavage de la vaisselle. Système d'extraction sans filtres.

LONGITUD CAMPANA	FONDO 1000		FONDO 1500	
	CÓDIGO	PRECIO	CÓDIGO	PRECIO
1000	V1010SF	842 €	V1015SF	945 €
1500	V1510SF	1.166 €	V1515SF	1.296 €
2000	V2010SF	1.382 €	V2015SF	1.530 €
2500	V2510SF	1.705 €	V2515SF	1.881 €
3000	V3010SF	1.921 €	V3015SF	2.115 €
3500	V3510SF	2.245 €	V3515SF	2.466 €
4000	V4010SF	2.460 €	V4015SF	2.700 €

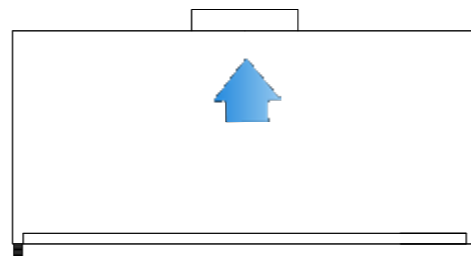

PLENUM PARA CAMPANA

PLENUM FOR HOOD / PLENUM POUR HOTTE

Fabricado en acero inoxidable AISI 304. Fabricado mediante soldadura. Pestañas de anclaje a campana.

Completely made of AISI 304, 18/10 stainless steel. Completely built by welding. Onglets d'ancrage en cloche.

Fabriqué en acier inoxydable AISI 304. Fabriqué par soudage. Onglets d'ancrage en cloche.

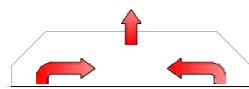

LONGITUD CAMPANA	PLENUM EXTRACCION CAMPANA MURAL			PLENUM EXTRACCION CAMPANA CENTRAL			PLENUM APORTACION CAMPANA CENTRAL		
	DIM.	CÓDIGO	PRECIO	DIM.	CÓDIGO	PRECIO	DIM.	CÓDIGO	PRECIO
2500	2000X400X350	V250PM	555 €	2000X800X350	V250PC	674 €	2000X400X350	V250PA	555 €
3000	2500X400X350	V300PM	584 €	2500X800X350	V300PC	715 €	2500X400X350	V300PA	584 €
3500	3000X400X350	V350PM	628 €	3000X800X350	V350PC	771 €	3000X400X350	V350PA	628 €
4000	3500X400X350	V400PM	667 €	3500X800X350	V400PC	822 €	3500X400X350	V400PA	667 €

Dimensiones en mm. Los precios indicados serán gravados con el I.V.A. correspondiente.

KIT DE ILUMINACIÓN PARA CAMPANA LIGHTING KIT FOR HOOD / KIT D'ÉCLAIRAGE POUR HOTTE



LONGITUD CAMPANA	CAMPANA CENTRAL		CAMPANA MURAL	
	CÓDIGO	PRECIO	CÓDIGO	PRECIO
1000	V100CILU	398 €	V100MILU	200 €
1500	V150CILU	514 €	V150MILU	256 €
2000	V200CILU	566 €	V200MILU	283 €
2500	V250CILU	680 €	V250MILU	341 €
3000	V300CILU	770 €	V300MILU	386 €
3500	V350CILU	887 €	V350MILU	442 €
4000	V400CILU	926 €	V400MILU	487 €

SISTEMA DE REGULACIÓN DE CAUDAL PARA CAMPANA

FLOW REGULATION SYSTEM FOR HOOD / SYSTÈME DE RÉGULATION DE DÉBIT POUR HOTTE

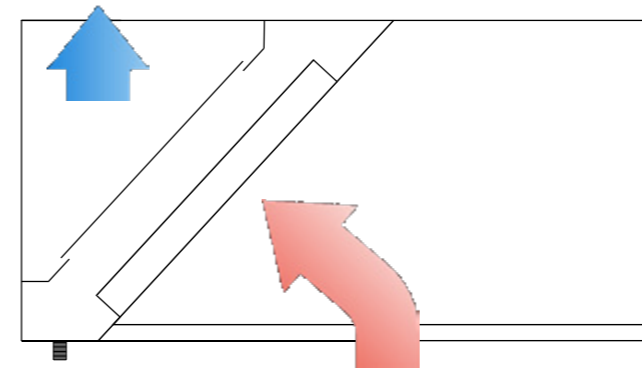

Fabricado en acero inoxidable AISI 304,18/10. Permite la regulación de caudal filtro a filtro favoreciendo la extracción en las zonas de más humo. Fabricado con compuertas deslizables.

Made of AISI 304, 18 / 10 stainless steel. It allows the regulation of the filter by filter flow, favoring extraction in the areas with the most smoke. Manufactured with slide gates.

Fabriqué en acier inoxydable AISI 304,18/10. Il permet la régulation du filtre par débit de filtre, favorisant l'extraction dans les zones les plus enfumées. Fabriqué avec des portes coulissantes.

LONGITUD CAMPANA	CAMPANA CENTRAL		CAMPANA MURAL	
	CÓDIGO	PRECIO	CÓDIGO	PRECIO
1500	V150CREG	865 €	V150MREG	486 €
2000	V200CREG	1.080 €	V200MREG	606 €
2500	V250CREG	897 €	V250MREG	786 €
3000	V300CREG	1.614 €	V300MREG	906 €
3500	V350CREG	1.936 €	V350MREG	1.086 €
4000	V400CREG	2.150 €	V400MREG	1.207 €

FILTROS PARA CAMPANAS

FILTERS FOR HOODS / FILTRES POUR HOTTES

Fabricado en acero inoxidable AISI 430. Eficacia gravimétrica 75%. Pérdida de carga inicial 80 Pa. Temperatura de trabajo 350°.

Made of AISI 430 stainless steel. Gravimetric efficiency 75%. Initial pressure loss 80 Pa. Working temperature 350°.

Fabriqué en acier inoxydable AISI 430. Efficacité gravimétrique 75%. Perte de charge initiale 80 Pa. Température de fonctionnement 350°.



DIMENSIONES	CÓDIGO	PRECIO
390x490x49	V45F	76 €
490x490x49	V55F	69 €

Buffet y autoservicio.

Buffet and self-service. / Buffet et libre-service.

	pág.
AUTOSERVICIO / SELF-SERVICE / LIBRE-SERVICE	102
PLACA FRIA / COLD PLATE / PLAQUE FROIDE	110
CUBA FRIA / COLD CUBE / CUVE FROIDE	110
CUBA FRIA VENTILADA / COLD CUBE BY AIR / PAR AIR	111
CUBA PARA HELADOS / ICE CREAM TANK / FROID CUBA POUR GLACE	111
PLACA CALIENTE / HOT PLATE / PLAQUE CHAUD	112
PLACA CALIENTE CON CRISTAL TEMPLADO / HOT PLATE WITH TEMPERED GLASS / PLAQUE CHAUFFANTE AVEC VERRE TREMPE	112
BAÑO MARIA / BAIN MARIE / BAIN-MARIE	113
BAÑO MARIA SECO / DRY BAIN MARIE / BAIN-MARIE SEC	113
PANTALLA RECTA / STRAIGHT SCREEN / ÉCRAN DE VERRE DROIT	114
PANTALLA CURVA / CURVE SCREEN / ÉCRAN COURBE	115
VITRINA REFRIGERADA / REFRIGERATED DISPLAY CASE / VITRINE RÉFRIGÉRÉE	115
ARMARIO PARA VACIADO DE BANDEJAS / CABINET FOR EMPTYING TRAYS / ARMOIRE POUR VIDER LES PLATEAUX	116
PLACA CALIENTE DE SOBREMESA / DESKTOP HOT PLATE / ASSIETTE CHAUFFANTE	116
BAÑO MARIA DE SOBREMESA / BAIN MARIE ON TABLE / BAIN-MARIE SUR TABLE	117
BAÑO MARIA SECO DE SOBREMESA / DRY BAIN MARIE ON TABLE / BAIN-MARIE SEC SUR TABLE	117



AUTOSERVICIO

SELF-SERVICE / LIBRE-SERVICE

Panelados para integrar vitrinas en auto servicio.

Panels to integrate showcases in self service.

Panneaux pour intégrer des vitrines en libre service.

Muebles auxiliares a medida en madera.

Auxiliary furniture made to measure in wood.

Meubles d'appoint sur mesure en bois.

Encimeras en Cuarzo (Silestone) o Solid Surface (Corian).

Quartz (Silestone) or Solid Surface (Corian) countertops.

Comptoirs en Quartz (Silestone) ou Solid Surface (Corian).

Decoración frontal personalizable.

Customizable front decoration.

Décoration avant personnalisable.

Zócalo en acero inoxidable AISI 304.

AISI 304 stainless steel plinth.

Socle en acier inoxydable AISI 304.

Carros para bandejas en acero inoxidable AISI 304.

Trolleys for trays in AISI 304 stainless steel.

Chariots pour plateaux en acier inoxydable AISI 304.

Lineales de autoservicio fabricados a medida, adaptados al espacio e integrando elementos del entorno. Diferentes opciones de decoración y diseño. Bastidor interior en estructura soldada de tubo de acero inoxidable AISI 304.

Self-service made to measure, adapted to the space and integrating elements of the environment. Different decoration and design options. Internal structure made of AISI 304 stainless steel tube welded structure.

Libre-service sur mesure, adaptées à l'espace et intégrant des éléments de l'environnement. Différentes options de décoration et de conception. Cadre intérieur en structure soudée en tube d'acier inoxydable AISI 304.

Módulo neutro con estantes.
Neutral module with shelves.
Module neutre avec étagères.

Equipos refrigerados encastrables.
Built-in refrigerated equipment.
Équipements réfrigérés intégrés.

Tomas eléctricas auxiliares.
Auxiliary electrical outlets.
Prises électriques auxiliaires.

Interiores en acero inoxidable AISI 304 para resistir al uso intensivo. Módulos extraíbles de fácil acceso a conexiones.

Interiors in AISI 304 stainless steel to withstand intensive use. Removable modules with easy access to connections.

Intérieurs en acier inoxydable AISI 304 pour résister à un usage intensif. Modules amovibles avec accès facile aux connexions.

Diseños personalizables en forma, decoración, acabados y equipos funcionales. Incluido mediciones y presentaciones en 3 dimensiones.

Customizable designs in form, decoration, finishes and functional equipment. Including measurements and 3-dimensional presentations.

Des designs personnalisables dans la forme, la décoration, les finitions et les équipements fonctionnels. Y compris les mesures et les présentations en 3 dimensions.



PLACA FRIA COLD PLATE / PLAQUE FROIDE



Totalmente fabricado en acero inoxidable AISI 304, 18/10. Aislado mediante poliuretano de alta densidad. Refrigeración mediante serpentín adherido a la parte inferior. Unidad hermética con refrigerante R134A o R290. Control de temperatura mediante termostato digital. Interruptor de encendido luminoso. Panel de mandos extraíble.

Completely made of AISI 304, 18/10 stainless steel. Insulated by high-density polyurethane. Cooling by means of a coil attached to the bottom. Hermetic unit with R134A or R290 refrigerant. Temperature control by digital thermostat. Luminous power switch. Removable control panel.

Entièrement en acier inoxydable AISI 304, 18/10. Isolation en polyuréthane haute densité. Refroidissement au moyen d'un serpentín fixé au fond. Unité hermétique avec réfrigérant R134A ou R290. Contrôle de la température par thermostat numérique. Interrupteur d'alimentation lumineux. Panneau de commande amovible.



FONDO 10 mm.

FONDO 30 mm.

FONDO 65 mm.

DIMENSIONES	MODELO	POTENCIA	DIM. ENCASTRE	CÓDIGO	PRECIO	CÓDIGO	PRECIO	CÓDIGO	PRECIO
720X600X75	2 GN	1/5 Cv	700X580	B2PF10	1.504 €	B2PF30	1.568 €	B2PF65	1.635 €
1045X600X75	3 GN	1/5 Cv	1025X580	B3PF10	1.594 €	B3PF30	1.631 €	B3PF65	1.717 €
1370X600X75	4 GN	1/5 Cv	1350X580	B4PF10	1.738 €	B4PF30	1.780 €	B4PF65	1.908 €
1695X600X75	5 GN	1/5 Cv	1675X580	B5PF10	1.982 €	B5PF30	1.990 €	B5PF65	2.151 €

CUBA FRIA COLD CUBE / CUVE FROIDE



Totalmente fabricado en acero inoxidable AISI 304, 18/10. Aislado mediante poliuretano de alta densidad. Refrigeración mediante serpentín adherido a la parte inferior. Unidad hermética con refrigerante R134A o R290. Control de temperatura mediante termostato digital. Interruptor de encendido luminoso. Panel de mandos extraíble.

Completely made of AISI 304, 18/10 stainless steel. Insulated by high-density polyurethane. Cooling by means of a coil attached to the bottom. Hermetic unit with R134A or R290 refrigerant. Temperature control by digital thermostat. Luminous power switch. Removable control panel.

Entièrement en acier inoxydable AISI 304, 18/10. Isolation en polyuréthane haute densité. Refroidissement au moyen d'un serpentín fixé au fond. Unité hermétique avec réfrigérant R134A ou R290. Contrôle de la température par thermostat numérique. Interrupteur d'alimentation lumineux. Panneau de commande amovible.

DIMENSIONES	MODELO	POTENCIA	DIM. ENCASTRE	CÓDIGO	PRECIO
720X600X650	2 GN	1/5 Cv	700X580	B2CFE	1.670 €
1045X600X650	3 GN	1/5 Cv	1025X580	B3CFE	1.723 €
1370X600X650	4 GN	1/5 Cv	1350X580	B4CFE	1.922 €
1695X600X650	5 GN	1/5 Cv	1675X580	B5CFE	2.175 €

CUBA FRIA VENTILADA COLD CUBE BY AIR / PAR AIR



Totalmente fabricado en acero inoxidable AISI 304, 18/10. Aislado mediante poliuretano de alta densidad. Refrigeración mediante aire refrigerado. Unidad hermética con refrigerante R134A o R290. Control de temperatura mediante termostato digital. Interruptor de encendido luminoso. Panel de mandos extraíble.

Completely made of AISI 304, 18/10 stainless steel. Insulated by high-density polyurethane. Cooling by cooled air. Hermetic unit with R134A or R290 refrigerant. Temperature control by digital thermostat. Luminous power switch. Removable control panel.

Entièrement en acier inoxydable AISI 304, 18/10. Isolation en polyuréthane haute densité. Refroidissement au air refroidi. Unité hermétique avec réfrigérant R134A ou R290. Contrôle de la température par thermostat numérique. Interrupteur d'alimentation lumineux. Panneau de commande amovible.

DIMENSIONES	MODELO	POTENCIA	DIM. ENCASTRE	CÓDIGO	PRECIO
775X730X740	2 GN	1/5 Cv	760X715	B2CFV	1.951 €
1100X730X740	3 GN	1/5 Cv	1085X715	B3CFV	2.102 €
1425X730X740	4 GN	1/5 Cv	1410X715	B4CFV	2.390 €
1750X730X740	5 GN	1/5 Cv	1735X715	B5CFV	2.686 €

CUBA PARA HELADOS ICE CREAM TANK / FROID CUBA POUR GLACE



Totalmente fabricado en acero inoxidable AISI 304, 18/10. Aislado mediante poliuretano de alta densidad. Refrigeración mediante serpentín adherido a la parte inferior. Unidad hermética con refrigerante R134A o R290. Control de temperatura mediante termostato digital. Interruptor de encendido luminoso. Panel de mandos extraíble.

Completely made of AISI 304, 18/10 stainless steel. Insulated by high-density polyurethane. Cooling by means of a coil attached to the bottom. Hermetic unit with R134A or R290 refrigerant. Temperature control by digital thermostat. Luminous power switch. Removable control panel.

Entièrement en acier inoxydable AISI 304, 18/10. Isolation en polyuréthane haute densité. Refroidissement au moyen d'un serpentín fixé au fond. Unité hermétique avec réfrigérant R134A ou R290. Contrôle de la température par thermostat numérique. Interrupteur d'alimentation lumineux. Panneau de commande amovible.

DIMENSIONES	MODELO	POTENCIA	DIM. ENCASTRE	CÓDIGO	PRECIO
825X550X635	4 CUB.	1/5 Cv	795X515	B4CFH	1.924 €

PLACA CALIENTE HOT PLATE / PLAQUE CHAUD



Totalmente fabricado en acero inoxidable AISI 304, 18/10. Calentamiento mediante resistencias adheridas a la parte inferior. Control de temperatura mediante termostato digital. Interruptor de encendido luminoso. Panel de mandos extraíble.

Completely made of AISI 304, 18/10 stainless steel. Heating by means of resistors attached to the bottom. Temperature control by digital thermostat. Luminous power switch. Removable control panel.

Entièrement en acier inoxydable AISI 304, 18/10. Chauffage au moyen de résistances fixées au fond. Contrôle de la température par thermostat numérique. Interrupteur d'alimentation lumineux. Panneau de commande amovible.

DIMENSIONES	MODELO	POTENCIA	DIM. ENCASTRE	CÓDIGO	PRECIO
720X600X160	2 GN	1 Kw	700X580	B2PC10	942 €
1045X600X160	3 GN	2 Kw	1025X580	B3PC10	1.082 €
1370X600X160	4 GN	3 Kw	1350X580	B4PC10	1.216 €
1695X600X160	5 GN	4 kW	1675X580	B5PC10	1.358 €

PLACA CALIENTE CON CRISTAL TEMPLADO HOT PLATE WITH TEMPERED GLASS / PLAQUE CHAUFFANTE AVEC VERRE TREMPÉ



Totalmente fabricado en acero inoxidable AISI 304, 18/10. Superficie de apoyo en cristal templado. Calentamiento mediante resistencias adheridas a la parte inferior. Control de temperatura mediante termostato digital. Interruptor de encendido luminoso. Panel de mandos extraíble.

Completely made of AISI 304, 18/10 stainless steel. Tempered glass support surface. Heating by means of resistors attached to the bottom. Temperature control by digital thermostat. Luminous power switch. Removable control panel.

Entièrement en acier inoxydable AISI 304, 18/10. Surface d'appui en verre trempé. Chauffage au moyen de résistances fixées au fond. Contrôle de la température par thermostat numérique. Interrupteur d'alimentation lumineux. Panneau de commande amovible.

DIMENSIONES	MODELO	POTENCIA	DIM. ENCASTRE	CÓDIGO	PRECIO
720X600X160	2 GN	2 Kw	700X580	B2PCV10	1.356 €
1045X600X160	3 GN	3 Kw	1025X580	B3PCV10	1.581 €
1370X600X160	4 GN	4 Kw	1350X580	B4PCV10	1.869 €
1695X600X160	5 GN	5 kW	1675X580	B5PCV10	2.104 €

BAÑO MARIA BAIN MARIE / BAIN-MARIE



Totalmente fabricado en acero inoxidable AISI 304, 18/10. Calentamiento mediante resistencias adheridas a la parte inferior. Control de temperatura mediante termostato digital. Interruptor de encendido luminoso. Panel de mandos extraíble.

Completely made of AISI 304, 18/10 stainless steel. Heating by means of resistors attached to the bottom. Temperature control by digital thermostat. Luminous power switch. Removable control panel.

Entièrement en acier inoxydable AISI 304, 18/10. Chauffage au moyen de résistances fixées au fond. Contrôle de la température par thermostat numérique. Interrupteur d'alimentation lumineux. Panneau de commande amovible.

DIMENSIONES	MODELO	POTENCIA	DIM. ENCASTRE	CÓDIGO	PRECIO
720X600X350	2 GN	1 Kw	700X580	B2BMH	1.321 €
1045X600X350	3 GN	2 Kw	1025X580	B3BMH	1.562 €
1370X600X350	4 GN	3 Kw	1350X580	B4BMH	1.754 €
1695X600X350	5 GN	4 kW	1675X580	B5BMH	2.111 €

BAÑO MARIA SECO DRY BAIN MARIE / BAIN-MARIE SEC



Totalmente fabricado en acero inoxidable AISI 304, 18/10. Calentamiento mediante resistencias en interior de la cuba. Control de temperatura mediante termostato digital. Interruptor de encendido luminoso. Panel de mandos extraíble.

Completely made of AISI 304, 18/10 stainless steel. Heating by means of resistances inside the tank. Temperature control by digital thermostat. Luminous power switch. Removable control panel.

Entièrement en acier inoxydable AISI 304, 18/10. Chauffage par résistances à l'intérieur de la cuve. Contrôle de la température par thermostat numérique. Interrupteur d'alimentation lumineux. Panneau de commande amovible.

DIMENSIONES	MODELO	POTENCIA	DIM. ENCASTRE	CÓDIGO	PRECIO
720X600X350	2 GN	1,5 Kw	700X580	B2BMS	1.060 €
1045X600X350	3 GN	2,25 Kw	1025X580	B3BMS	1.140 €
1370X600X350	4 GN	3 Kw	1350X580	B4BMS	1.342 €
1695X600X350	5 GN	3,75 kW	1675X580	B5BMS	1.683 €

PANTALLA RECTA

STRAIGHT SCREEN / ÉCRAN DE VERRE DROIT



Estructura fabricada en acero inoxidable AISI 304, 18/10. Cristal templado recto a ambos lados. Paneles laterales extraíbles. Iluminación tipo led o calor mediante lámparas halógenas.

Structure made of AISI 304, 18/10 stainless steel. Straight tempered glass on both sides. Removable side panels. Lighting type led or heat using halogen lamps.

Structure en acier inoxydable AISI 304, 18/10. Verre trempé droit des deux côtés. Panneaux latéraux amovibles. Eclairage de type led ou chauffant utilisant des lampes halogènes.

DIMENSIONES	MODELO	NEUTRO		CON LUZ		CON LUZ Y CALOR	
		CÓDIGO	PRECIO	CÓDIGO	PRECIO	CÓDIGO	PRECIO
865X600X500	2 GN	B2PSN	532 €	B2PSL	681 €	B2PSC	822 €
1190X600X500	3 GN	B3PSN	580 €	B3PSL	762 €	B3PSC	922 €
1520X600X500	4 GN	B4PSN	610 €	B4PSL	822 €	B4PSC	1.022 €
1840X600X500	5 GN	B5PSN	624 €	B5PSL	896 €	B5PSC	1.118 €

PANTALLA CURVA

CURVE SCREEN / ÉCRAN COURBE



Estructura fabricada en acero inoxidable AISI 304, 18/10. Cristal templado curvo. Paneles laterales extraíbles. Iluminación tipo led o calor mediante lámparas halógenas.

Structure made of AISI 304, 18/10 stainless steel. Curved tempered glass. Removable side panels. Lighting type led or heat using halogen lamps.

Structure en acier inoxydable AISI 304, 18/10. Verre trempé bombé. Panneaux latéraux amovibles. Eclairage de type led ou chauffant utilisant des lampes halogènes.

DIMENSIONES	MODELO	NEUTRO		CON LUZ		CON LUZ Y CALOR	
		CÓDIGO	PRECIO	CÓDIGO	PRECIO	CÓDIGO	PRECIO
880X600X550	2 GN	B2PSNC	780 €	B2PSLC	867 €	B2PSCC	1.014 €
1210X600X550	3 GN	B3PSNC	800 €	B3PSLC	889 €	B3PSCC	986 €
1530X600X550	4 GN	B4PSNC	863 €	B4PSLC	959 €	B4PSCC	1.155 €
1860X600X550	5 GN	B5PSNC	1.333 €	B5PSLC	1.481 €	B5PSCC	1.727 €

PANTALLA RECTA DOBLE

DOUBLE STRAIGHT SCREEN / DOUBLE ÉCRAN DROIT



Estructura fabricada en acero inoxidable AISI 304, 18/10. Cristal templado recto a ambos lados. Paneles laterales extraíbles. Iluminación tipo led o calor mediante lámparas halógenas.

Structure made of AISI 304, 18/10 stainless steel. Straight tempered glass on both sides. Removable side panels. Lighting type led or heat using halogen lamps.

Structure en acier inoxydable AISI 304, 18/10. Verre trempé droit des deux côtés. Panneaux latéraux amovibles. Eclairage de type led ou chauffant utilisant des lampes halogènes.

DIMENSIONES	MODELO	NEUTRO		CON LUZ		CON LUZ Y CALOR	
		CÓDIGO	PRECIO	CÓDIGO	PRECIO	CÓDIGO	PRECIO
865X600X600	2 GN	B2PSND	715 €	B2PSLD	871 €	B2PSCD	1.013 €
1190X600X600	3 GN	B3PSND	781 €	B3PSLD	984 €	B3PSCD	1.148 €
1520X600X600	4 GN	B4PSND	842 €	B4PSLD	1.063 €	B4PSCD	1.301 €
1840X600X600	5 GN	B5PSND	908 €	B5PSLD	1.168 €	B5PSCD	1.416 €

VITRINA REFRIGERADA

REFRIGERATED DISPLAY CASE / VITRINE RÉFRIGÉRÉE



Totalmente fabricado en acero inoxidable AISI 304, 18/10. Laterales y puertas en cristal templado. Evaporador en parte superior. Unidad hermética incluida. Estantes interiores en varilla de acero inoxidable. Sin base. Temperatura controlada por termostato digital. Interruptor luminoso.

Completely made of AISI 304, 18/10 stainless steel. Sides and doors in tempered glass. Evaporator in the upper part. Hermetic unit included. Inner shelves in stainless steel rod. Without base. Temperature controlled by digital thermostat. Luminous switch.

Entièrement en acier inoxydable AISI 304, 18/10. Côtés et portes en verre trempé. Évaporateur en partie haute. Unité hermétique incluse. Étagères intérieures en tige d'acier inoxydable. Sans socle. Température contrôlée par thermostat numérique. Interrupteur lumineux.

DIMENSIONES	MODELO	CON BASE AISLADA		SIN BASE	
		CÓDIGO	PRECIO	CÓDIGO	PRECIO
1185X730X950	3 GN	B3VRCB	4.356 €	B3VRSB	4.081 €
1510X730X950	4 GN	B4VRCB	4.545 €	B4VRSB	4.297 €

ARMARIO PARA VACIADO DE BANDEJAS

CABINET FOR EMPTYING TRAYS / ARMOIRE POUR VIDER LES PLATEAUX



Cubo de desperdicios no incluido

Fabricado totalmente en acero inoxidable **AISI 304, 18/10**. Encimera en 1,2 mm. de espesor. Varillas perimetrales de acero inoxidable para el alojamiento de bandejas. Armario inferior con tolva de vaciado basculante. Puerta inferior abatible con cierre magnético. Patas de acero inoxidable con pie regulable en altura de rosca oculta. Se entrega totalmente montado.

Made entirely of AISI 304, 18/10 stainless steel. Countertop in 1.2 mm. of thickness. Stainless steel perimeter rods to accommodate trays. Lower cabinet with tilting emptying hopper. Lower hinged door with magnetic closure. Stainless steel legs with height adjustable foot with hidden thread. It is delivered fully assembled.

Fabriqué entièrement en acier inoxydable AISI 304, 18/10. Plan de travail en 1,2 mm. d'épaisseur. Tiges de périmètre en acier inoxydable pour accueillir les plateaux. Meuble bas avec trémie de vidange basculante. Porte battante inférieure avec fermeture magnétique. Pieds en acier inoxydable avec pied réglable en hauteur avec filetage caché. Il est livré entièrement monté.

DIMENSIONES	CÓDIGO	PRECIO
700X700X1250	CONT77	1.150 €

PLACA CALIENTE DE SOBREMESA

DESKTOP HOT PLATE / ASSIETTE CHAUFFANTE



Totalmente fabricado en acero inoxidable AISI 304, 18/10. Calentamiento mediante resistencias adheridas a la parte inferior. Control de temperatura mediante termostato digital. Interruptor de encendido luminoso. Panel de mandos extraíble.

Completely made of AISI 304, 18/10 stainless steel. Heating by means of resistors attached to the bottom. Temperature control by digital thermostat. Luminous power switch. Removable control panel.

Entièrement en acier inoxydable AISI 304, 18/10. Chauffage au moyen de résistances fixées au fond. Contrôle de la température par thermostat numérique. Interrupteur d'alimentation lumineux. Panneau de commande amovible.

DIMENSIONES	POTENCIA	CÓDIGO	PRECIO
1000X400X80	1 Kw	G2PCS	522 €
1200X400X80	2 Kw	G3PCS	558 €
1400X400X80	4 kW	G6PCS	591 €

BAÑO MARIA DE SOBREMESA

BAIN MARIE ON TABLE / BAIN-MARIE SUR TABLE



Totalmente fabricado en acero inoxidable AISI 304, 18/10. Calentamiento mediante resistencias adheridas a la parte inferior. Control de temperatura mediante termostato digital. Interruptor de encendido luminoso. Panel de mandos extraíble.

Completely made of AISI 304, 18/10 stainless steel. Heating by means of resistors attached to the bottom. Temperature control by digital thermostat. Luminous power switch. Removable control panel.

Entièrement en acier inoxydable AISI 304, 18/10. Chauffage au moyen de résistances fixées au fond. Contrôle de la température par thermostat numérique. Interrupteur d'alimentation lumineux. Panneau de commande amovible.

DIMENSIONES	MODELO	POTENCIA	CÓDIGO	PRECIO
500X650X350	2 GN	1 Kw	G2BMHS	993 €
820X650X350	3 GN	2 Kw	G3BMHS	1.370 €
1150X350X350	4 GN	3 kW	G4BMHS	1.616 €

BAÑO MARIA SECO DE SOBREMESA

DRY BAIN MARIE ON TABLE / BAIN-MARIE SEC SUR TABLE



Totalmente fabricado en acero inoxidable AISI 304, 18/10. Calentamiento mediante resistencias en interior de la cuba. Control de temperatura mediante termostato digital. Interruptor de encendido luminoso. Panel de mandos extraíble.

Completely made of AISI 304, 18/10 stainless steel. Heating by means of resistances inside the tank. Temperature control by digital thermostat. Luminous power switch. Removable control panel.

Entièrement en acier inoxydable AISI 304, 18/10. Chauffage par résistances à l'intérieur de la cuve. Contrôle de la température par thermostat numérique. Interrupteur d'alimentation lumineux. Panneau de commande amovible.

DIMENSIONES	MODELO	POTENCIA	CÓDIGO	PRECIO
500X650X350	2 GN	0,75 Kw	G2BMSS	923 €
820X650X350	3 GN	1,5 Kw	G3BMSS	1.143 €
1150X350X350	4 GN	2,25 kW	G4BMSS	1.301 €



Proyectos e Instalaciones.

Projects and Installations. / Projets et Installations.





ALWAYS READY
by mediterránea



Forever
green
by mediterránea





**PAGO CON
TARJETA DE
CRÉDITO**
Aceptamos pago
Aceptamos el pago con tarjeta de crédito
¡Mucha paz!

**ACCEDER A
INTRANET**
Qué hay para comer

**ACCEDER A
INTRANET**
Qué hay para comer

**ESTAMOS
FUERA
DE
SERVICIO**
Para más información

caja



BUFFET de ens





PRIMEROS

SEGUNDOS

TERCEROS

MENU DEL DIA





CONDICIONES GENERALES DE VENTA

ÁMBITO DE APLICACIÓN.

Las condiciones generales de venta se aplicarán a todos los productos que A-CERO INOX S.L. presenta en este catálogo y en la página web www.A-CEROINOX.com, así como a cualquier otro producto que, fabricado o comercializado por A-CERO INOX S.L., no esté presente en el catálogo.

Todos los productos presentados en este catálogo están amparados por la normativa europea vigente dentro del ámbito de fabricación de A-CERO INOX S.L..

A-CERO INOX S.L. se reserva el derecho de modificar los artículos presentados en este catálogo y en la página web www.A-CEROINOX.com sin previo aviso. Dicha modificación no dará derecho a compensación alguna.

PEDIDO.

Los pedidos no se considerarán válidos hasta su recepción por escrito. Después de emitir un pedido es aconsejable solicitar una confirmación de recepción del mismo. A-CERO INOX S.L. se reserva el derecho de aceptación de pedidos de venta así como de modificación de los precios presentes en este catálogo sin previo aviso.

PRECIOS.

Este catálogo indica el precio venta al público, en €, que será incrementado con el I.V.A. correspondiente. Los precios indicados no incluyen la instalación ni la puesta en marcha de los equipos entregados. La instalación y puesta en marcha deberán ser ofertadas de manera independiente.

PLAZO DE ENTREGA.

Al recibir el pedido, confirmaremos el plazo de entrega en el que vamos a servir la mercancía. La mercancía incluida en el presente catálogo está supe-ditada a un proceso de fabricación por lo que el plazo de entrega facilitado por A-CERO INOX S.L. tendrá carácter orientativo. Los retrasos en la entrega no podrán dar lugar a penalización alguna o indemnización por daños y perjuicios. El retraso en la entrega de artículos de fabricación especial no facultará al comprador para anular el pedido. A-CERO INOX S.L. no admitirá en ningún caso penalizaciones o reclamaciones de ningún tipo por retraso en la entrega de un producto.

TRANSPORTE.

Para los pedidos inferiores a 300 € los gastos de transporte serán a cargo del cliente. Consultar el precio del transporte para envíos fuera de la península. La mercancía viaja siempre a cuenta y riesgo del comprador, tanto en el caso de que los portes sean pagados como si los portes van debidos.

Cuando la mercancía viaje a portes pagados por A-CERO INOX S.L. el cliente tiene que notificarle a A-CERO INOX S.L. por escrito dentro de las 24 horas siguientes a la recepción de la mercancía, cualquier defecto o tara imputable a la agencia de transportes para facilitar la reclamación de la responsabilidad de acuerdo a la Ley 16/1.987 de Ordenación de los Transportes Terrestres y RD 1.111/1.990 por el que se aprueba el reglamento de la Ley de Ordenación de Transportes Terrestres. No será admitida ninguna devolución de mercancía cuya tara o defecto sea imputable a la agencia de transporte, excepto que el cliente se lo notifique a A-CERO INOX S.L. y/o a la Agencia de Transportes dentro de las 24 horas siguientes a la recepción de la mercancía o en el plazo legalmente establecido en cada momento en la Ley de Ordenación de Transportes Terrestres. En caso de recepción de la mercancía con defectos imputables al transporte, tendrá que quedar constatado en la hoja de transporte o albarán de entrega, los defectos observados para su posterior reclamación.

RECLAMACIONES Y DEVOLUCIONES.

No se aceptará ninguna devolución transcurridos treinta días desde la fecha de recepción de la mercancía indicada en el albarán de entrega del transportista. No se aceptará ninguna devolución de material sin el previo consentimiento de A-CERO INOX S.L. No se admitirá, en ningún caso, la devolución de materiales usados o probados, ni tampoco los que no lleven su embalaje original. En ningún caso se aceptará la devolución de productos especiales o a medida. Cualquier devolución injustificada de material, en caso de abonarse, sufrirá una depreciación automática del 30% sobre el importe facturado. Todos los gastos generados por devoluciones, incluidos los gastos de transportes, serán por cuenta del cliente. La reclamación por golpes o deterioro ocasionado por el transporte no será aceptada si no va acompañada del comprobante de reclamación efectuada por el comprador a la agencia de transporte en un plazo máximo de 24 horas desde la recepción de la mercancía.

GARANTÍA.

La garantía será de 12 meses desde la fecha de envío del material. Sólo estarán cubiertos aquellos defectos derivados de la fabricación. Quedan excluidos los defectos derivados de un mal uso, ubicación o manipulación del producto. La garantía incluye la recogida y sustitución del equipo entregado o el envío del componente defectuoso. El cliente se compromete a enviar a A-CERO INOX S.L. el componente dañado. En caso de no cumplir este requisito, en el plazo de 15 días desde la recepción del componente de sustitución, A-CERO INOX S.L. procederá a facturar el componente enviado. La garantía no incluye el desplazamiento de ningún técnico a la instalación donde esté el producto, ni la mano de obra empleada en la reparación del mismo, sí incluye la retirada y reparación del producto en fábrica. A-CERO INOX S.L. no se hará cargo de ningún tipo de indemnización. La intervención de técnicos ajenos al equipo de A-CERO INOX S.L. invalida de forma automática la garantía.

FORMA DE PAGO.

Todas las operaciones serán abonadas mediante pago anticipado salvo que el comprador tenga acordadas otras condiciones con el departamento administrativo de A-CERO INOX S.L. De no producirse el pago de las facturas en los vencimientos acordados, el comprador se hará cargo de los gastos de devolución y del interés legal de demora del 2% mensualmente. Todos los gastos que se originen, tanto judiciales como extra judiciales, bancarios, notariales, etc ... por el impago de una factura, correrán a cargo del comprador. Los equipos de fabricación especial serán pagados total o parcialmente por adelantado.

RESERVA DE DOMINIO.

A-CERO INOX S.L. se reserva el dominio de la mercancía hasta el pago total de la misma por parte del cliente.

JURISDICCIÓN.

Serán únicamente competentes, en caso de litigio, los tribunales de Alcalá de Henares.

GENERAL CONDITIONS OF SALE

APPLICATION RANGE.

The general terms and conditions of sale will be applied to all the products that A-CERO INOX presents in this catalogue and on the website www.A-CEROINOX.com, as well as any other product manufactured or marketed by A-CEROINOX that is not included in the catalogue. All the products presented in this catalogue are covered by the European regulations in force within the scope of manufacture of A-CERO INOX S.L.

A-CERO INOX S.L. reserves the right to modify the articles presented in this catalogue and on the website www.ACEROINOX.com without prior notice. Such modification shall not give right to any compensation.

ORDER:

Orders shall not be considered valid until received in writing. After placing an order, it is advisable to request confirmation of receipt of the order.

A-CEROINOX S.L. reserves the right to accept sales orders and to modify the prices in this catalogue without prior notice.

PRICES.

This catalogue indicates the retail price, in €, which will be taxed with the corresponding V.A.T.. The prices indicated do not include the installation and start-up of the equipment delivered. Installation and commissioning may be offered separately.

DELIVERY TIME.

Upon receipt of the order we will confirm the delivery time within which we will deliver the goods. The goods included in this catalogue are subject to a manufacturing process, so the delivery time given by A-CEROINOX S.L. will be of an indicative nature. Delays in delivery shall not give rise to any penalties or compensation for damages. The delay in the delivery of articles of special manufacture shall not entitle the buyer to cancel the order. ACERO INOX will not admit in any case penalties or claims of any kind for delay in the delivery of the product.

TRANSPORT.

For orders under 300 € the transport costs will be charged to the customer. Consult the price of transport for shipments outside the peninsula.

The goods always travel at the risk and expense of the buyer, both in the case that the postage is paid and if the postage is due.

When the goods are shipped carriage paid by A-CEROINOX S.L. the customer must notify A-CEROINOX S.L. in writing within 24 hours of receipt of the goods following the reception of the goods, any defect or fault attributable to the transport agency in order to facilitate the claim of liability according to the Law 16/1.987 of Land Transport Management and RD 1.111/1.990 which approves the regulations of the Law of Land Transport Management of Land Transport. No return of goods whose tare or defect is attributable to the transport agency shall be admitted, unless the client notifies A-CEROINOX S.L. and/or the Transport Agency within 24 hours of receipt of the goods or within the legally established period at any given time in the legally established period at any time in the Law of Land Transport Management. In the event of receipt of the goods with defects attributable to the transport, it will have to remain the defects observed must be noted on the transport document or delivery note for subsequent complaint.

CLAIMS AND RETURNS.

No returns will be accepted after thirty days from the date of receipt of the goods indicated on the carrier's delivery note.

No return of material will be accepted without the prior consent of A-CEROINOX S.L. The return of used or tested materials will not be accepted under any circumstances of used or tested materials, nor those that do not have their original packaging. Under no circumstances will the return of special or custom-made products be accepted. Any unjustified return of material, if paid for, will suffer an automatic depreciation of 30% of the invoiced amount.

All costs generated by returns, including transport costs, shall be borne by the customer. Claims for damage or deterioration caused by transport will not be accepted if it is not accompanied by proof of the claim made by the purchaser to the transport agency within a maximum period of 24 hours from the date of delivery.

WARRANTY.

The warranty will be 24 months from the date of shipment of the material. Only manufacturing defects will be covered. The defects resulting from misuse, misplacement or mishandling of the product are excluded. The warranty includes the collection and replacement of the equipment delivered or the shipment of the the delivery of the defective component. The customer undertakes to send A-CEROINOX S.L. the damaged component. If this requirement is not fulfilled, within 15 days from the reception of the replacement component, A-CEROINOX S.L. will proceed to invoice the sent component. The guarantee does not include the displacement of any technician to the installation where the product is, nor the labour used in the repair of the product, but it does include the removal and repair of the product in the factory. The removal and repair of the product in the factory. A-CEROINOX S.L. will not be responsible for any type of compensation. The intervention of technicians outside the A-CEROINOX team automatically invalidates the guarantee.

METHOD OF PAYMENT.

All operations will be paid in advance unless the buyer has agreed other conditions with the administrative department of A-CEROINOX S.L. If the invoices are not paid on the agreed due dates, the purchaser will be responsible for the costs of return and the legal interest on late payment of 2% per month. All costs arising, both judicial and extra judicial, banking, notary, etc ... due to non-payment of an invoice shall be borne by the purchaser. Specially manufactured equipment shall be paid in full or in part in advance.

RESERVATION OF TITLE.

A-CEROINOX S.L. reserves the ownership of the goods until full payment of the same by the customer.

JURISDICTION.

The courts of Alcalá de Henares shall have sole jurisdiction in the event of litigation.

CONDITIONS GENERALES DE VENTE

DOMAINE D'APPLICATION.

Les conditions générales de vente s'appliqueront à tous les produits que A-CERO INOX S.L. Il est présenté dans ce catalogue et sur le site www.A-CEROINOX.com, ainsi que tout autre produit qui, fabriqué ou commercialisé par A-CERO INOX S.L., n'est pas présent dans le catalogue. Tous les produits présentés dans ce catalogue sont couverts par la réglementation européenne en vigueur dans le cadre de la fabrication de A-CERO INOX S.L. A-CERO INOX S.L. se réserve le droit de modifier les articles présentés dans ce catalogue et sur le site www.A-CEROINOX.com sans préavis. Cette modification ne donnera droit à aucune indemnité.

COMMANDER.

Les commandes ne seront considérées comme valides qu'après réception par écrit. Après avoir passé une commande, il est conseillé de demander un accusé de réception. A-CERO INOX S.L. se réserve le droit d'accepter les commandes ainsi que de modifier les prix de ce catalogue sans préavis.

DES PRIX.

Ce catalogue indique le prix public, en €. Les prix indiqués ne comprennent pas l'installation ou la mise en service du matériel livré. L'installation et la mise en service doivent être proposées indépendamment.

DÉLAI DE LIVRAISON.

Dès réception de la commande, nous vous confirmerons le délai de livraison dans lequel nous allons servir la marchandise. La marchandise incluse dans ce catalogue est soumise à un processus de fabrication, de sorte que le délai de livraison prévu par A-CERO INOX S.L. Ce sera à titre indicatif. Les retards de livraison ne pourront donner lieu à aucune pénalité ni indemnité pour dommages et intérêts. Le retard dans la livraison des articles de fabrication spéciale n'autorisera pas l'acheteur à annuler la commande. A-CERO INOX S.L. En aucun cas, il n'acceptera de pénalités ou réclamations de quelque nature que ce soit pour retard de livraison d'un produit.

TRANSPORT.

Pour les commandes inférieures à 300 €, les frais de transport seront à la charge du client. Vérifiez le prix du transport pour les envois en dehors de la péninsule. La marchandise voyage toujours aux risques et frais de l'acheteur, tant en cas de port payé que si le port est dû. Lorsque la marchandise voyage en port payé par A-CERO INOX S.L. le client doit informer A-CERO INOX S.L. par écrit dans les 24 heures suivant la réception de la marchandise, tout défaut ou tare imputable à l'agence de transport pour faciliter la revendication de responsabilité conformément à la loi 16/1987 sur la réglementation des transports terrestres et RD 1 111 / 1990, qui approuve les règlements de la loi d'ordonnance sur les transports terrestres. Aucun retour de marchandise dont le vice ou le défaut est imputable à l'agence de transport ne sera accepté, à moins que le client n'informe A-CERO INOX S.L. et/ou à l'Office des transports dans les 24 heures suivant la réception de la marchandise ou dans le délai légalement établi de temps à autre dans la Loi sur la gestion des transports terrestres. En cas de réception de la marchandise présentant des défauts imputables au transport, les défauts constatés doivent être notés sur le bordereau de transport ou le bon de livraison pour réclamation ultérieure.

RÉCLAMATIONS ET RETOURS.

Aucun retour ne sera accepté après trente jours à compter de la date de réception de la marchandise indiquée sur le bon de livraison du transporteur. Aucun retour de matériel ne sera accepté sans le consentement préalable de A-CERO INOX S.L. Le retour de matériel utilisé ou testé, ni de ceux qui n'ont pas leur emballage d'origine, ne sera en aucun cas accepté. En aucun cas le retour de produits spéciaux ou personnalisés ne sera accepté. Tout retour de matériel injustifié, s'il est payé, subira une dépréciation automatique de 30% sur le montant facturé. Tous les frais générés par les retours, y compris les frais de transport, seront à la charge du client. La réclamation pour coups ou dommages causés par le transport ne sera pas acceptée si elle n'est pas accompagnée du justificatif de réclamation formulé par l'acheteur auprès de l'agence de transport dans un délai maximum de 24 heures à compter de la réception de la marchandise.

GARANTIE.

La garantie sera de 12 mois à compter de la date d'expédition du matériel. Seuls les défauts dérivés de la fabrication seront couverts. Les défauts résultant d'une mauvaise utilisation, de l'emplacement ou de la manipulation du produit sont exclus. La garantie comprend la collecte et le remplacement du matériel livré ou l'expédition du composant défectueux. Le client s'engage à envoyer A-CERO INOX S.L. le composant endommagé. Si cette exigence n'est pas remplie, dans les 15 jours suivant la réception du composant de remplacement, A-CERO INOX S.L. procédera à la facturation du composant envoyé. La garantie n'inclut pas le déplacement de tout technicien à l'installation où se trouve le produit, ni la main-d'œuvre utilisée pour le réparer, elle comprend le retrait et la réparation du produit à l'usine. A-CERO INOX S.L. ne sera pas responsable de tout type de compensation. L'intervention de techniciens extérieurs à A-CERO INOX S.L. annule automatiquement la garantie.

MODE DE PAIEMENT.

Toutes les opérations seront payées par acompte à moins que l'acheteur n'ait convenu d'autres conditions avec le service administratif de A-CERO INOX S.L. Si le paiement des factures n'intervient pas aux échéances convenues, l'acheteur sera à la charge des frais de retour et des intérêts légaux de retard de 2% mensuels. Tous les frais qui découleraient, tant judiciaires qu'extrajudiciaires, bancaires, notariés, etc... du non-paiement d'une facture, seront à la charge de l'acheteur. Les équipements de fabrication spéciaux seront payés en totalité ou en partie à l'avance.

RÉSERVATION DE TITRE.

A-CERO INOX S.L. Le domaine de la marchandise est réservé jusqu'au paiement total de celle-ci par le client.

JURIDICTION.

Seuls les tribunaux d'Alcalá de Henares seront compétents, en cas de litige.



Calle Industria 4-6
Pol. Ind. Alcamar
Camarma de Esteruelas
C.P.: 28816 (Madrid)
Teléf.: +34 916 035 460
e-mail: info@a-ceroinox.com
web: www.a-ceroinox.com